



PHOENIX

SWISS MADE

OPERATOR'S MANUAL



PHOENIX PREDATOR



Read and understand all instructions and warnings in this manual carefully before using this firearm!

CONTENTS

	Page	Page	
Warning	3	Reassembly of the firing pin	25
About this operator's manual	4	Handling and operation	
Signs and symbols	4	of the pistol	26
Exclusion of liability and warranty	4	Shooting in	
State-by-State-Warnings	5	special climatic conditions	26
Your safety responsibilities	7	Preparing the pistol for shooting	27
Safe storage and transportation	9	Filling the magazine	27
Ammunition	10	Loading the pistol	27
Basic safety instructions	13	Firing the pistol	29
Operator's manual	13	Firing in single / double action mode	30
Safety instructions		Reloading the pistol	
for the handling of pistols	13	when magazine is empty	31
Safety features	14	Reloading the pistol	
Safety instructions for drop safety	14	when magazine is NOT empty	31
Malfunctions	14	Unloading the pistol	
Safety instructions for firing	15	when magazine is NOT empty	32
Handing over the weapon	15	Unloading the pistol	
Storage, transport and disposal	15	when magazine is empty	32
Unusual stresses	15	Unloading a NOT empty magazine	32
Technical safety instructions	16	Disassembly of the pistol	33
Use of accessories	16	Reassembly of the pistol	34
Preliminary notes	16	Cleaning and Care	35
Scope of delivery	17	Normal / Major cleaning	35
Technical data	18	Magazines	36
PHOENIX PREDATOR STANDARD		Disassembly / Reassembly	
with open sights	18	of the magazine	36
PHOENIX PREDATOR «CARRY OPTIC»		Sights of the pistol	37
with red dot sight	18	Change between sights and optics	38
Main components of the pistol	19	Change of the grip panel	39
Operating controls,		Maintenance and regular checking	40
designations, variants	20	Checking / replacement	
Function and use of		of the recoil buffer	40
operating controls	21	Notes	41
Safety lever	21	Malfunctions and errors;	
Magazine catch lever	21	Cause and elimination	42
Slide release lever	21	Clearing a misfire	42
Trigger	22	Clearing a misfeed («JAM»)	42
Safety check (clearing)		Clearing a bullet stuck in the bore	43
before and after every use	22	Trouble shooting chart	44
Functional test of the pistol	23	List of parts / spare parts orders	46
Functional test of the smooth		Scheme (explosion drawing)	47
operation of the firing pin	24		
Disassembly of the firing pin	24		
Cleaning of the firing pin	25		

WARNING!

FIREARMS SAFETY AND SAFE GUN HANDLING IS YOUR N° 1 RESPONSIBILITY AT ANY TIME AND IN ANY CASE!

SAFETY MUST BE THE FIRST AND CONSTANT CONSIDERATION OF EVERY PERSON WHO HANDLES FIREARMS AND AMMUNITION.

READ THESE INSTRUCTIONS AND WARNINGS CAREFULLY. BE SURE YOU UNDERSTAND THESE INSTRUCTIONS AND WARNINGS BEFORE USING THIS FIREARM.

FAILURE TO READ THESE INSTRUCTIONS AND TO FOLLOW THESE WARNINGS MAY RESULT IN SERIOUS INJURY OR DEATH TO YOU AND/OR OTHERS AND/OR DAMAGE TO PROPERTY.

DO NOT USE THIS OR ANY OTHER FIREARM WITHOUT HAVING A COMPLETE UNDERSTANDING OF ITS PARTICULAR CHARACTERISTICS AND SAFE USE!

Only when you are certain you have fully familiarized yourself with the function of your firearm should you practice loading, unloading, and firing etc. with live rounds of ammunition!

IT IS YOUR RESPONSIBILITY TO COMPLY WITH ALL FEDERAL, STATE AND LOCAL LAWS AND REGULATIONS REGARDING THE OWNERSHIP OR POSSESSION OF THIS FIREARM and any conversions or additions of any after-market accessories that you undertake.

If you have any doubts about your ability to handle or use a particular type of gun safely, you should seek supervised instruction. Such personalized instruction often is available from local gun retailers, gun clubs or police departments. If none of these sources can help, visit www.nra.org or write to the following address:

National Rifle Association
11250 Waples Mill Road
Fairfax, VA 22030-7400



THIS OPERATOR'S MANUAL SHOULD ALWAYS ACCOMPANY THIS FIREARM AND BE TRANSFERRED WITH IT UPON CHANGE OF OWNERSHIP, OR WHEN THE FIREARM IS LOANED OR PRESENTED TO ANOTHER PERSON!

ABOUT THIS OPERATOR'S MANUAL

This operator's manual is dedicated to persons who are authorized to use the described weapon. This operator's manual describes the construction, the function, and the handling of the pistol. To understand this operator's manual basic knowledge about the technical rules of shooting and firearms is indispensable. **WARNING: This operator's manual cannot replace proper shooting instruction and training!**

SIGNS AND SYMBOLS

Important information and technical notes are marked as follows:

Symbol	Meaning
 DANGER	Imminent danger! Hazardous situation which, if not avoided, will result in death or serious injury!
 WARNING	Potential danger! Hazardous situation which, if not avoided, may result in death or serious injury!
 ATTENTION	Dangerous situation! Hazardous situation which, if not avoided, may result in minor or moderate injury!
CAUTION !	Situation which, if not avoided, may result in damage of the weapon and/or property.

EXCLUSION OF LIABILITY AND WARRANTY

PHX PHOENIX AG does not assume any liability and provides no warranty for incidents due to:

- disregarding this operator's manual or non-compliance with this operator's manual and/or wrong/incorrect handling of the pistol.
- negligence, improper treatment or improper or illegal use of the pistol.
- any modifications, attachments to or conversion of the weapon and/or the use of accessories or spare parts from other manufacturers without the express written consent of PHX PHOENIX AG.
- the use of non-factory loaded (self-loaded) cartridges, damaged cartridges, cartridges of wrong caliber or of +P+ ammunition.
- inadequate care, maintenance, and cleaning as well as all influences that cannot be controlled directly or immediately by PHX PHOENIX AG.

STATE-BY-STATE-WARNINGS

Certain states require by law that their own specified warning notices in larger-than-normal type be conspicuously included by the manufacturer, distributor, or retailer with firearms sold in that state. PHX PHOENIX AG sells its products in compliance with applicable laws and regulations. Because our products may be sold in these states, we include the following:

California

«Firearms must be handled responsibly and securely stored to prevent access by children and other unauthorized users. California has strict laws pertaining to firearms, and you may be fined or imprisoned if you fail to comply with them. Visit the Web site of the California Attorney General at <https://oag.ca.gov/firearms> for information on firearm laws applicable to you and how you can comply.»

«Prevent child access by always keeping guns locked away and unloaded when not in use. If you keep a loaded firearm where a child obtains and improperly uses it, you may be fined or sent to prison.»

Advertencia

«Las armas de fuego deben manipularse de manera responsable y segura para evitar el acceso de niños y otros usuarios no autorizados. California tiene leyes estrictas relacionadas con armas de fuego, y usted puede ser multado o encarcelado si no las cumple. Visite el sitio web del Procurador General de California en <https://oag.ca.gov/firearms> para obtener información sobre las leyes de armas de fuego que le son aplicables y cómo puede cumplirlas.»

«A los niños los atraen las armas de fuego y las pueden hacer funcionar. Ellos pueden causarse lesiones graves y la muerte. Evite que los niños tengan acceso a las armas de fuego guardándolas siempre con llave y descargadas cuando no las esté utilizando. Si usted tiene un arma de fuego cargada en un lugar en que un niño tiene acceso a ella y la usa indebidamente, le pueden dar una multa o enviarlo a la cárcel.»

Connecticut

«UNLAWFUL STORAGE OF A LOADED FIREARM MAY RESULT IN IMPRISONMENT OR FINE.»

Florida

«IT IS UNLAWFUL, AND PUNISHABLE BY IMPRISONMENT AND FINE, FOR ANY ADULT TO STORE OR LEAVE A FIREARM IN ANY PLACE WITHIN THE REACH OR EASY ACCESS OF A MINOR UNDER 18 YEARS OF AGE OR TO KNOWINGLY SELL OR OTHERWISE TRANSFER OWNERSHIP OR POSSESSION OF A FIREARM TO A MINOR OR A PERSON OF UNSOUND MIND.»

Maine

«ENDANGERING THE WELFARE OF A CHILD IS A CRIME. IF YOU LEAVE A FIREARM AND AMMUNITION WITHIN EASY ACCESS OF A CHILD, YOU MAY BE SUBJECT TO FINE, IMPRISONMENT OR BOTH. KEEP FIRE-ARMS AND AMMUNITION SEPARATE AND LOCKED UP. USE TRIGGER LOCKS.»

Maryland

«WARNING: Children can operate firearms which may cause death or serious injury. It is a crime to store or leave a loaded firearm in any location where an individual knew or should have known that an unsupervised minor would gain access to the firearm. Store your firearm responsibly!» →

STATE-BY-STATE-WARNINGS

continued

Massachusetts

«WARNING FROM THE MASSACHUSETTS ATTORNEY GENERAL: This handgun is not equipped with a device that fully blocks use by unauthorized users. More than 200 000 firearms like this one are stolen from their owners every year in the United States. In addition, there are more than a thousand suicides each year by younger children and teenagers who get access to firearms. Hundreds more die from accidental discharge. It is likely that many more children sustain serious wounds or inflict such wounds accidentally on others. In order to limit the chance of such misuse, it is imperative that you keep this weapon locked in a secure place and take other steps necessary to limit the possibility of theft or accident. Failure to take reasonable preventive steps may result in innocent lives being lost, and in some circumstances may result in your liability for these deaths.»

«IT IS UNLAWFUL TO STORE OR KEEP A FIREARM, RIFLE, SHOTGUN OR MACHINE GUN IN ANY PLACE UNLESS THAT WEAPON IS EQUIPPED WITH A TAMPER-RESISTANT SAFETY DEVICE OR IS STORED OR KEPT IN A SECURELY LOCKED CONTAINER.»

New Jersey

«IT IS A CRIMINAL OFFENSE TO LEAVE A LOADED FIREARM WITHIN EASY ACCESS OF A MINOR.»

New York City

«THE USE OF A LOCKING DEVICE OR SAFETY LOCK IS ONLY ONE ASPECT OF RESPONSIBLE FIREARM STORAGE. FOR INCREASED SAFETY, FIREARMS SHOULD BE STORED UNLOADED AND LOCKED IN A LOCATION THAT IS BOTH SEPARATE FROM THEIR AMMUNITION AND INACCESSIBLE TO CHILDREN AND UNAUTHORIZED PERSONS.»

North Carolina

«IT IS UNLAWFUL TO STORE OR LEAVE A FIREARM THAT CAN BE DISCHARGED IN A MANNER THAT A REASONABLE PERSON SHOULD KNOW IS ACCESSIBLE TO A MINOR.»

Texas

«IT IS UNLAWFUL TO STORE, TRANSPORT, OR ABANDON AN UNSECURED FIREARM IN A PLACE WHERE CHILDREN ARE LIKELY TO BE AND CAN OBTAIN ACCESS TO THE FIREARM.»

Wisconsin

«IF YOU LEAVE A LOADED FIREARM WITHIN THE REACH OR EASY ACCESS OF A CHILD YOU MAY BE FINED OR IMPRISONED OR BOTH IF THE CHILD IMPROPERLY DISCHARGES, POSSESSES, OR EXHIBITS THE FIREARM.»

IMPORTANT NOTE

It is your responsibility to comply with all Federal, State and Local Laws and regulations regarding the ownership or possession of this firearm! Please check with your licensed retailer or state police for additional warnings which may be required by local law or regulation. Such regulations change constantly, and local authorities are in the best position to advise you on such legal matters.

YOUR SAFETY RESPONSIBILITIES



WARNING

YOU MUST FOLLOW ALL OF THE FOLLOWING SAFETY RULES TO ENSURE THE SAFE USE OF YOUR FIREARM.

THE FAILURE TO FOLLOW THE INSTRUCTIONS AND WARNINGS IN THIS MANUAL COULD CAUSE SERIOUS PERSONAL INJURY OR DEATH TO YOU AND/OR OTHERS AND/OR DAMAGE TO PROPERTY.

- At home, in the field, at the range, or anywhere, the first concern of every firearm owner should be safety. **Apply the following safety rules in every situation, with any kind of firearm.** If you feel uncertain about any operational aspects of your firearm, don't use it.
- If you are unfamiliar with firearms, you should seek formal training before using this pistol.
- As a firearm owner, you accept a demanding responsibility. How seriously you take this responsibility can be the difference between life and death. **There is no excuse for careless or abusive handling of your firearm.** At all times handle your firearm with intense respect for its power and potential danger.
- **ALWAYS KEEP YOUR FIREARM POINTED IN A SAFE DIRECTION.** Never point a firearm at anyone or anything you do not intend to shoot whether or not it is loaded. This is particularly important when loading, unloading, or field stripping the firearm. **ALWAYS control the direction of the firearm.**
- **ALWAYS TREAT EVERY FIREARM AS IF IT IS LOADED AND WILL FIRE.** Do not take anyone's word that the firearm is unloaded! Always check for yourself. Never pass your firearm to another person until the cylinder or action is open and you have visually checked that the firearm is unloaded.
- **KEEP YOUR FIREARM UNLOADED AND SAFELY STORED WHEN NOT IN USE.**
- **NEVER PLACE YOUR FINGER INSIDE THE TRIGGER GUARD OR ON THE TRIGGER UNLESS YOU INTEND TO FIRE.** Ensure that other objects do not touch the trigger.
- **ALWAYS BE SURE OF YOUR TARGET AND WHAT IS BEYOND IT.** Always be sure of where the bullet will strike and shoot only where there is a safe back stop free of obstructions, water or other surfaces which can cause a ricochet. Be sure your bullet will stop behind your target. Bullets can glance off many surfaces like rocks or the surface of water and travel in unpredictable directions with considerable velocity. Do not fire randomly into the sky.
- **NEVER CROSS OBSTACLES SUCH AS FENCES OR STREAMS WITH A LOADED FIREARM.** Always make certain your firearm is unloaded before crossing a fence, climbing a tree, jumping a ditch, or negotiating other obstacles.
- **SAFE FIREARM HANDLING IS YOUR PERSONAL RESPONSIBILITY AT ALL TIMES.** Firearms are dangerous and can cause serious injury or death if they are misused or used inappropriately. Safety must be the prime consideration of anyone who owns or handles firearms. Accidents are the result of violating the rules of safe firearm handling and common sense. Firearm safety training is available. Contact your firearms dealer, law enforcement agency, local sportsman's club, etc. for availability.
- **YOU ARE RESPONSIBLE FOR THE FIREARM AT ALL TIMES.** In owning a firearm, you must undertake full-time responsibility for your firearm's safety and security. You must protect yourself and all others against injury or death from misuse of the firearm 24 hours a day. ⇨

YOUR SAFETY RESPONSIBILITIES

continued

- **FIREARM SECURITY IS YOUR RESPONSIBILITY.** You must secure firearms safely from children and/or unauthorized users. Your firearm should always be kept unloaded and locked when not in use. A lock has been provided for this purpose. Never assume that the use of this lock is sufficient to safely secure your firearm. You must always evaluate your personal situation and employ the security systems that meet your needs and prevent children and unauthorized users from gaining access to your firearm.
- **APPROPRIATE USE FOR YOUR FIREARM MEANS USING YOUR FIREARM FOR LEGAL PURPOSES.** For example, target shooting, hunting and lawful resistance of deadly criminal force. It is your responsibility to ensure that you are in compliance with all applicable laws and ordinances regarding the use of your firearm.
- **NEVER RELY ON MECHANICAL FEATURES ALONE.** Only your safe firearm-handling habits will ensure the safe use of your firearm. This is your responsibility.
- **ALWAYS SAFELY STORE AND SECURE YOUR FIREARM.** Safe and secure storage of your firearm is one of your most important responsibilities. It is a full-time responsibility. You must always secure your firearm and ammunition separately so that they are not accessible to children and/or other unauthorized persons.
- **NEVER KEEP AMMUNITION IN THE SAME LOCATION AS THE FIREARM.** Store each in a separate and secure place.
- **ALWAYS WEAR EYE PROTECTION THAT IS SPECIFIED FOR USE WITH FIREARMS** every time you handle your firearm for cleaning and maintenance.
- **ALWAYS WEAR EYE AND HEARING PROTECTION THAT ARE SPECIFIED FOR USE WITH FIREARMS** every time you discharge your firearm. Make sure others in the vicinity of where you will be shooting do so as well.
- **NEVER USE ALCOHOL OR DRUGS BEFORE OR WHILE SHOOTING.** Do not use your firearm if you are on any medication which impairs, even slightly, your mental or physical ability.
- **ALWAYS HAVE ADEQUATE VENTILATION.** Discharging firearms in poorly ventilated areas, cleaning firearms, or handling ammunition may result in exposure to lead and other substances known to cause birth defects, reproductive harm, and other serious physical injury. Review the warnings and labels for all ammunition and cleaning products carefully. Wash hands thoroughly after exposure.
- **BEFORE HANDLING ANY FIREARM, UNDERSTAND ITS OPERATION.** Not all firearms are the same. Familiarize yourself with the mechanical features of any firearm you intend to use. If you feel uncertain about any operational aspects of your firearm, don't use it.
- **NEVER ALLOW A FIREARM TO BE USED BY INDIVIDUALS WHO DO NOT UNDERSTAND ITS SAFE OPERATION OR HAVE NOT READ THESE FIREARM SAFETY RULES.**
- **ALWAYS USE THE CORRECT AMMUNITION FOR YOUR PARTICULAR FIREARM** as indicated by the marking on the firearm. Never use non-standard, reloaded, or hand-loaded ammunition which has not been subjected to internal ballistic pressure testing.
- **BESURE ALL ACCESSORIES, SUCH AS HOLSTERS, GRIPS, SLINGS, SCOPES AND OTHER ACCESSORIES, ARE FULLY COMPATIBLE** with the firearm and that all mounted to the weapon or otherwise used accessories **DO NOT** interfere with safe operation. **IT IS YOUR PERSONAL RESPONSIBILITY** to understand and follow all of the instructions in this manual, as well as those which may be supplied with your ammunition and any accessory.

YOUR SAFETY RESPONSIBILITIES

continued

- **BEWARE OF BARREL OBSTRUCTIONS.** Be sure the barrel is clear of obstructions before shooting. Mud, water, snow, oil, or other objects may inadvertently lodge in the barrel bore. A small obstruction can cause a dangerous increase in pressure and may damage your firearm and cause injury to yourself and others.
- **NEVER DISASSEMBLE YOUR FIREARM** beyond the field stripping procedure outlined in this manual. Improper disassembly or reassembly of your firearm may be dangerous and can lead to serious injury or death.
- **NEVER MANIPULATE, ADJUST OR CHANGE ANY OF THE INTERNAL COMPONENTS OF YOUR FIREARM UNLESS SPECIFICALLY INSTRUCTED TO DO SO IN THIS MANUAL.** Improper manipulation of any other internal component may affect the safety and reliability of your firearm and may cause serious injury or death.
- **NEVER ALLOW ANY ALTERATION OR REPLACEMENT OF PARTS IN YOUR FIREARM UNLESS PERFORMED BY A QUALIFIED GUNSMITH** using genuine parts from PHX PHOENIX AG. If you do otherwise, improper functioning of your firearm may occur and serious injury or death and damage to property may result.

SAFE STORAGE AND TRANSPORTATION



WARNING

- **FIREARMS ARE DANGEROUS WHEN USED AND STORED IMPROPERLY. THEY POSE A RISK OF SERIOUS OR FATAL INJURIES. FIREARMS CAN BE ESPECIALLY DANGEROUS TO CHILDREN WHEN THEY ARE STORED IN AN IRRESPONSIBLE AND UNSAFE MANNER.**
- **FOR YOUR SAFETY AND THE SAFETY OF OTHERS, IT IS IMPERATIVE THAT YOU KEEP YOUR FIREARM LOCKED AND UNLOADED IN A SECURE PLACE. THE AMMUNITION SHOULD BE STORED IN A SEPARATE, SECURE LOCATION WHEN IT IS NOT IN USE. SAFE AND SECURE STORAGE OF YOUR FIREARM IS ONE OF THE MOST IMPORTANT RULES OF FIREARM SAFETY. YOUR FAILURE TO FOLLOW THESE RULES MAY RESULT IN SERIOUS INJURY OR DEATH TO YOU AND/OR OTHERS.**
- **ALWAYS SECURE YOUR FIREARM IN A MANNER THAT WILL PREVENT UNAUTHORIZED ACCESS.** Whenever your firearm is not in use, keep it unloaded and locked. Your safety and the safety of others requires that you always secure and store your firearm in a manner that will prevent unauthorized access. Never leave a firearm unattended unless it is locked, unloaded, and secured.
- **ALWAYS USE A LOCK SPECIFIED FOR USE WITH FIREARMS TO SECURE YOUR FIREARM.** A lock, when properly used, can be an effective tool in preventing unauthorized access to your firearm. There are different locks and safe storage containers available in the marketplace. Consult your local firearm shop, hardware store, or local police department for guidance on the variety of safe storage devices or practices which may be appropriate for your particular needs. By purchasing this firearm, you have accepted the responsibility of safely securing the firearm at all times and preventing its unauthorized use. Never assume that the use of a lock alone is sufficient to safely secure your firearm. It is your personal responsibility to select and use whatever measures or practices that will enable you to be absolutely certain that your firearm is secure at all times. ⇨

SAFE STORAGE AND TRANSPORTATION

continued

WARNING

- **NEVER LOCK A LOADED FIREARM.**
- **DO NOT LEAVE OR STORE YOUR UNLOADED FIREARM**

WITH THE KEY IN THE LOCK! STORE YOUR UNLOADED AND LOCKED FIREARM AND THE KEY TO THE LOCK IN SECURE, SEPARATE LOCATIONS, AWAY FROM AMMUNITION, CHILDREN AND UNAUTHORIZED PERSONS.

- **ALWAYS STORE YOUR FIREARM AND AMMUNITION SEPARATELY** so that they are not accessible to children or other unauthorized persons. Safe and secure storage of your firearm and ammunition are your responsibility. It is a full-time responsibility.
- **NEVER ASSUME THAT A «HIDING» PLACE IS A SECURE STORAGE METHOD.** Others may be aware of your storage location or come upon it by chance. It is your personal responsibility to use common sense when storing your firearm and ammunition and to always make sure they are not accessible to children or other unauthorized persons.
- **NEVER TRANSPORT A LOADED FIREARM.** When transporting your firearm, be sure it is unloaded and locked. Safe and secure transportation of your firearm is your responsibility.
- **ALWAYS FOLLOW THE LAW!** Many jurisdictions have laws that make it a crime to keep a firearm unlocked and in an area, accessible to children or others. Keeping a firearm locked and unloaded when not in use is not only common-sense safety practice... IT IS THE LAW. You must be familiar with all local, state, and federal laws regarding the safe storage and transportation of your firearm. Failure to know and follow the law may result in unauthorized access or use of your firearm by another. Obey all laws relating to the storage and transportation of firearms. Your local police department or firearm shop can furnish you with available information on storing and/or transporting a firearm safely and legally.
- **YOUR FIREARM IS YOUR RESPONSIBILITY.** You must prevent your firearm from being stolen or from being used by untrained or unqualified individuals. Keep it locked, unloaded, and secured when not in use.

AMMUNITION

WARNING

- **NEVER USE AMMUNITION WHICH IS NOT SPECIFICALLY DESIGNATED FOR USE IN YOUR FIREARM.**

FAILURE TO USE THE CORRECT TYPE OR CALIBER OF AMMUNITION MAY CAUSE THE FIREARM TO JAM, FAIL TO FIRE, OR MAY GENERATE EXCESSIVE PRESSURE WHICH CAN DAMAGE OR EVEN RUPTURE YOUR FIREARM, CAUSING SEVERE PERSONAL INJURY OR DEATH TO THE SHOOTER AND/OR TO BYSTANDERS.

- **ALWAYS INSPECT YOUR AMMUNITION THOROUGHLY BEFORE USING IT.** NEVER USE DIRTY, CORRODED OR IN ANY WAY DAMAGED AMMUNITION. A BURSTING CARTRIDGE MAY RESULT CAUSING DAMAGE TO THE FIREARM AND SEVERE PERSONAL INJURY OR DEATH TO THE SHOOTER AND/OR BYSTANDERS.
- **IN SOME CASES, A ROUND OF AMMUNITION NOT SPECIFIED ON YOUR FIREARM AND NOT LISTED AS ALTERNATE AMMUNITION IN THIS MANUAL, MAY FIT INTO THE CHAMBER. FIRING THIS AMMUNITION MAY CAUSE A RUPTURE RESULTING IN DAMAGE TO**

AMMUNITION

continued

THE FIREARM AND PERSONAL INJURY OR DEATH TO THE SHOOTER OR BYSTANDERS. FOR MORE INFORMATION REGARDING UNSAFE CALIBER COMBINATIONS, REFER TO THE FOLLOWING URL:

<https://saami.org/technical-information/unsafe-firearm-ammunition-combinations/>

- **NEVER USE NON-STANDARD, RELOADED OR HAND-LOADED AMMUNITION WHICH HAS NOT BEEN SUBJECTED TO INTERNAL BALLISTIC PRESSURE TESTING.**

Reloaded or hand loaded ammunition may have many manufacturing and quality variables such as the type and amount of gun powder.

Cartridge cases that have been reloaded and fired multiple times may suffer physical damage which could significantly impact or reduce the integrity of the cartridge, possibly resulting in bullet setback or unseating. Case failure and injury to the shooter or bystanders and damage to the firearm may result when such a round is fired.

Any ammunition that is improperly manufactured or reloaded, even in the slightest degree, may fail to fire or may generate excessive internal pressures which can damage or even rupture the firearm, causing personal injury or death to the shooter or those in the immediate vicinity.

- **DISCHARGING FIREARMS IN POORLY VENTILATED AREAS, CLEANING FIREARMS, OR HANDLING AMMUNITION MAY RESULT IN EXPOSURE TO LEAD AND OTHER SUBSTANCES KNOWN TO CAUSE BIRTH DEFECTS, REPRODUCTIVE HARM, AND OTHER SERIOUS PHYSICAL INJURY. HAVE ADEQUATE VENTILATION AT ALL TIMES. WASH HANDS THOROUGHLY AFTER EXPOSURE.**
- **NEVER USE AMMUNITION OF THE INCORRECT GAUGE OR CALIBER. USING AMMUNITION OF THE INCORRECT GAUGE OR CALIBER MAY CAUSE DAMAGE TO YOUR FIREARM AND POSSIBLE SERIOUS INJURY TO YOU AND TO OTHERS.**
- **NEVER USE CARTRIDGES OTHER THAN THOSE DESIGNATED BY THE MARKING ON THE FIREARM.** Doing so can result in dangerously high pressures that may damage the firearm and possibly cause serious injury or death to yourself and others.
- **DEATH, SERIOUS INJURY AND PROPERTY DAMAGE CAN RESULT FROM THE USE OF INCORRECT AMMUNITION OR BORE OBSTRUCTIONS. NEVER USE RELOADED AMMUNITION THAT HAS NOT BEEN SUBJECTED TO INTERNAL BALLISTIC PRESSURE TESTING.**
- **ALWAYS USE AMMUNITION OF THE CORRECT TYPE AND CALIBER.** This firearm model is offered in several caliber options. **LOCATE THE CARTRIDGE DESIGNATION (CALIBER) DIRECTLY MARKED ON THE WEAPON!** This information indicates the correct ammunition that MUST be used in your firearm. You are responsible for selecting ammunition that meets industry standards and is appropriate in type and caliber for this firearm.
- **NEVER MIX AMMUNITION.**
- A firearm and ammunition are a system and must work together. There are different types of ammunition for different types of firearms. Your firearm has been designed for ammunition of a specific type and a specific gauge or caliber. It is important to select the proper ammunition for your firearm.
- Different combinations of bullet velocity, bullet weight and firearm weight can have major impact on felt recoil; high felt recoil can be uncomfortable to some shooters. ⇨

AMMUNITION

continued

WARNING

- Use only clean, dry, factory-loaded, and undamaged new ammunition of the correct caliber which corresponds to the specifications of the C.I.P. or SAAMI standardization organizations. The use of low powered cartridges could lead to functional stoppages (including bullets stuck in the barrel) and is not recommended.

● NEVER USE

- dirty, wet, rusty, damaged, oiled, recycled, non-factory loaded/self-loaded cartridges or ammunition about the quality and/or origin of which you are not sure.
- Foreign or outdated ammunition as well as non-jacketed or exposed lead ammunition.
- Corrosive ammunition (primer and/or propellant).
- Empty cases as «dummy» (inert) rounds, as damage may result. Use complete dummy rounds available for training purposes.
- Any ammunition that exceeds NATO or SAAMI (Sporting Arms and Ammunition Manufacturers' Institute) pressure limits.
- Cartridges that are not of the right caliber for your weapon (9 x 19 mm)
- Corroded, wet or dirty ammunition.
- Dented Cartridges.
- Cartridges with loose bullets.
- Cartridges exposed to extreme heat above 135 °F (57 °C) until they have cooled.
- Unauthorized ammunition that is not manufactured to NATO and SAAMI specs.

CAUTION!

- Use of ammunition manufactured with corrosive primers will cause oxidation to develop on any exposed metal parts of the pistol. Conventional oil or solvent-based firearm cleaners WILL NOT dissolve the residue from corrosive primers. Check with the ammunition manufacturer or a qualified gunsmith if you are unsure whether the particular ammunition you plan to use has been manufactured with corrosive primers. If in doubt, use another ammunition manufactured without corrosive primers. Ammunition manufactured by SAAMI member companies do not use corrosive primers.

WARNING

Only use proper loaded ammunition of the correct caliber!

- All models and variants of the PHOENIX PREDATOR pistols in the calibers 9 x 19 mm (9 mm para; 9 mm Luger) have been approved for all ammunition types according to SAAMI and C.I.P., including US +P ammunition.
- Use only properly loaded ammunition of well-known manufacturers, delivered in original packing and of the correct caliber (imprinted on the barrel).
- Always follow all valid provisions for handling weapons and ammunition.

BASIC SAFETY INSTRUCTIONS

WARNING

Always follow the subsequent safety instructions!

- Observe at all times all safety instructions and notes regarding handling and operation. Disregarding can cause danger to life and limb.

WARNING

The PHOENIX PREDATOR pistol has been designed, manufactured, and inspected according to the latest technical knowledge and the recognized safety-related technical rules and regulations. **Nevertheless, the use of the pistol may result in injury or death of the user and third parties, or damage to the weapon and/or other material property.**

- Follow all the instructions in this operator's manual. Non-compliance may result in injury or death.
- Never handle the weapon if you are tired, feeling unwell, or when you have previously consumed alcohol, drugs, or any type of medicine.
- Always follow the instructions provided by their respective manufacturers when using accessories and ammunition.
- Always follow all valid provisions for handling weapons, accessories, and ammunition.

Operator's manual (OM)

- The OM is an integral component of the weapon. Keep the OM for the entire service life of the weapon and pass the OM to any subsequent operator or owner.
- Do not use the weapon until you have read and understood this OM completely.

Safety instructions for the handling of pistols

WARNING

- Special care must be taken when handling pistols because the position and direction of the weapon can be changed very easily.
- Use the weapon only for its intended purpose. Do not use the weapon as a club, hammer, pry bar, etc. Using the weapon for other than its intended purpose may result in accidental discharge of weapon or damage to the weapon.
- Always treat the weapon as if it is loaded and ready to fire until you have performed a personal safety check/clearing (see page 22).
- Before handling, in case of trouble and before cleaning, ascertain
 - whether the pistol is unloaded (cartridge chamber free),
 - whether the barrel is free of obstructions and
 - whether the magazine is empty.
- Use the weapon only if it is in perfect technical condition.
- Do not «play» with the pistol. A weapon is not a toy!

BASIC SAFETY INSTRUCTIONS

continued

- **Never point the weapon at people, animals, or anything else you do not want to destroy.** Always point the weapon in a safe direction.
- **Make sure that the weapon is always unloaded when it is handled for purposes other than loading or firing.**
- **Keep your finger(s) off the trigger** when loading, unloading, aiming, drawing or handling the weapon in any other way.
- **Always place your trigger finger on the outside of the trigger guard.**
- **Never use force** when handling, disassembling, cleaning, and reassembling the weapon.

Safety features



WARNING

- **Never rely on safety features.** Safety features are no substitute for careful, correct, and safe handling of the pistol. **Make sure that the safety lever is always clicked to the «Safe»-position.**

Safety instructions for drop safety

- Drop safety is affected by many factors, such as: fall height/angle, ground, type/frequency of impact, handling and treatment and loading and safety status of the weapon, accessories and equipment configuration of the weapon and the ammunition used. Regardless of a weapon's manufacturer or model, absolute drop safety is not possible and can only be checked based on defined test parameters.



WARNING

- **Make sure that the weapon is always unloaded when it is handled for purposes other than loading or firing.**

- Always ensure for weapons with a safety lever that the safety lever is not put to the «FIRE»-Position earlier than immediately before firing.
- Set the safety lever to the «SAFE»-Position during every pause in firing.

Malfunctions



WARNING

- **Users are strictly prohibited from troubleshooting faults that go beyond the scope of this operator's manual!**

Only authorized specialists may rectify mechanical faults in the weapon.

- **Always treat the weapon as if it were loaded in the event of a malfunction.**
- **Immediately rectify any faults/malfunctions that compromise safety.** If rectification is impossible, stop handling the weapon until a specialist has been able to repair the weapon.
- **Disassemble the pistol only as far as described in this manual.**
- In case of faults/errors/malfunctions that you cannot solve by your own or that go beyond the scope of this operator's manual **hand over the weapon to the manufacturer** or to authorized specialists/trained firearms personnel for inspection/repair.

BASIC SAFETY INSTRUCTIONS

continued

Safety instructions for firing



WARNING

- **Always respect the warnings and the rules concerning your safety responsibilities given on pages 5–12.**

- **Always wear eye and hearing protection that are specified for the use with firearms.**
- **Do not grasp over the muzzle and always keep the muzzle area clear when firing.**
- After firing wear protective gloves when touching the barrel or other parts of the pistol which heat up during firing.
- **Only use properly loaded, undamaged and correct ammunition** (see pages 10–12).
- **Always keep your fingers off the slide and behind the muzzle area when shooting.**
- **Pull the trigger only if the weapon sights are pointing at the intended target and if you are sure that the areas between you and the target, beside the target and behind the target is not endangered.** Observe the rule «Be sure of your target» (bullet trap, check environment, etc.).
- **The trigger must be pulled back completely when firing the pistol. Mind that when firing in rapid succession, the trigger must be released completely and return to the fully forward position AFTER EVERY SHOT.**

Handing over the weapon



WARNING

- **Do not hand over/entrust the pistol to any person who is not entitled to possess the weapon. Observe all applicable regulations.**

- Do not entrust the pistol to any person who has not comprehensively read and completely understood this operator's manual.
- Never hand over or receive the pistol unless it is unloaded, and the slide is opened.

Storage, transport, and disposal



WARNING

- **Always respect the rules for «safe storage and transportation» given on pages 9–10.**

- **Always store the pistol and ammunition separately** and be sure to prevent access to the pistol and ammunition by unauthorized persons, especially children.
- **Always follow the applicable provisions** for the transport, the shipping, the destroying and the disposal of weapons and ammunition.

Unusual stresses

- **Exposure to unusual/exceptional stresses such as when the weapon is banged or dropped can have a negative effect on safety.** After exceptional stresses, have the weapon inspected by the manufacturer or trained firearms personnel.

TECHNICAL SAFETY INSTRUCTIONS

CAUTION!

- **Always prevent dry firing of the pistol.** Dry firing of the hammer/firing pin can lead to premature wear.

Use of accessories

- At regular intervals inspect any accessories mounted on the weapon (e.g., silencers, lights or optics) for secure attachment.
- Always follow the details and the operator's manual from the respective manufacturers of any accessories mounted on the weapon.

PRELIMINARY NOTES

The PHOENIX PREDATOR pistol is a **self-loading pistol with a locked and buffered breech system**. It works with a semi-automatic recharge, according to the principle of the mechanically locked recoil loader.

The PHOENIX PREDATOR pistol is available in **different calibers** (marked on the barrel) **and versions** (not all versions available in every country) as well as in **different variants** (Single Action/Double Action, Single Action only, variant with manual safety).

A perfect function and long life of the PHOENIX PREDATOR pistol can only be ensured by a correct handling, operation and maintenance subject to the instructions of this operator's manual.

The indications «right», «left», «at the front» and «at the back» are related to the shooter's point of view when he holds the pistol in his hands and looks at it as when firing.

Each description of pistol parts, each function and each manipulation are only specified once. Therefore, there will be a reference to already covered descriptions of pistol parts, functions and manipulations in other sections.



WARNING

Only use original spare parts manufactured by PHX PHOENIX!

- **Use only original spare parts from PHX PHOENIX AG. Otherwise, the manufacturer liability and the warranty will be void.**
- **When ordering spare parts please mention the identification numbers as well as the designation (see also page 46 and 47). For ordering spare parts for a variant of the PHOENIX PREDATOR pistol you will find the corresponding parts listed on page 46 and an explosion drawing at page 47.**

SCOPE OF DELIVERY*

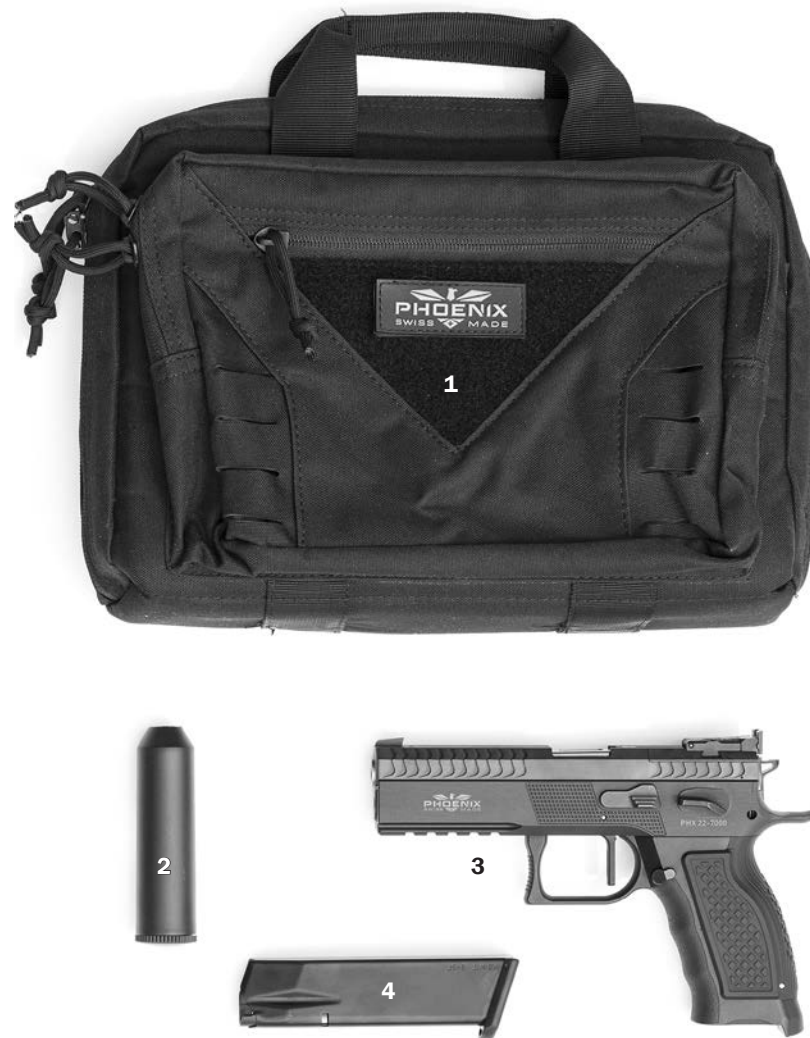

- 1 PHX PHOENIX pistol bag (made of Cordura)
- 2 PHX PHOENIX pistol cleaning kit (see also page 35)
- 3 PHOENIX PREDATOR pistol with open sights, mounted on a plate
- 4 Magazine (2 pieces)
- 5 Operator's manual (in your hands!)

* The scope of delivery is not the same in every country. Please refer to www.phx.swiss

TECHNICAL DATA

PHOENIX PREDATOR STANDARD with open sights

Model	PHOENIX PREDATOR STANDARD
Calibre	9 x 19 mm (9 mm Para; 9 mm Luger)
Slide	Steel
Upper frame	Aluminum
Lower frame	Polymer; interchangeable grip panels
Trigger system ¹	«SA/DA» or «SA only» with manual safety (<i>ambidextrous</i>)
Threaded barrel	<i>Optional: M 13,5 x 1 left</i>
Mounting	Picatinny 1913
Barrel length	115.5 mm
Magazine capacity*	17+1 rounds
Total length	211.2 mm
Total width	30 mm
Total height	145.6 mm (with Magazin)
Weight (g)	890 g
Colours	Black
Front sight	Open sight, steel, interchangeable <i>Optional: Open sight, steel, with optic fibre (green or red); Open sight, steel, with tritium point</i>
Rear sight	Bo-Mar-Style, steel, black, adjustable in windage and elevation with hardened click screws; mounted on the PHX-Plate. <i>Optional: «OR LPA»-style rear sight, steel, black, adjustable in windage and elevation with hardened click screws; mounted on the PHX-Plate.</i>
Grip Panels	Polymer; <i>Optional: Aluminum</i>

¹ *Optional there are different grip panels, different safety levers (big/small), a «leverless» slide release pin instead of the slide release lever and a straight trigger (standard for the «SA only»-variant) available. For information, please refer to www.phx.swiss.*

² *For some countries all variants are also available with 10-round-magazines*

³ *Weight without magazine (Empty magazine: 89 g)*

PHOENIX PREDATOR «CARRY OPTIC» with red dot sight

Model	PHOENIX PREDATOR «CARRY OPTIC»
Optic	Different red dots sights available (www.phx.swiss)
Total length	211.2 mm
Total width	30 mm
Total height	145.6 – 167.9 mm, depending on the measurements of the mounted red dot sight

MAIN COMPONENTS OF THE PISTOL



1 Slide; complete including sights

2 Barrel (*cal. 9 x 19 mm*)

3 Recoil buffer (*refer to page 40*)

4 Recoil spring guide rod

5 Recoil spring

6 Frame; complete (*upper and lower*)

7 Slide release lever

8 Magazine; complete

OPERATING CONTROLS, DESIGNATIONS, VARIANTS

PHOENIX PREDATOR STANDARD «SA only»



- | | |
|-------------------------|---------------------------|
| 1 Front Sight | 8 Safety lever, left, big |
| 2 Rear Sight | 9 Mountin rail |
| 3 Barrel | 10 Trigger guard |
| 4 Slide | 11 Trigger «SA only» |
| 5 Hammer | 12 Magazine release lever |
| 6 Frame (upper & lower) | 13 Grip panel (Alu PR) |
| 7 Slide release lever | 14 Magazine |

PHOENIX PREDATOR «CARRY OPTIC» «SA only»



- | | |
|-------------------------|------------------------------|
| 1 Front Sight | 8 Safety lever, right, small |
| 2 Red dot sight | 9 Mounting rail |
| 3 Barrel | 10 Trigger guard |
| 4 Slide | 11 Trigger «SA only» |
| 5 Hammer | 13 Grip panel (Alu PR) |
| 6 Frame (upper & lower) | 14 Magazine |

FUNCTION AND USE OF OPERATING CONTROLS

Safety Lever (ambidextrous)

The safety lever ⑧ is used to activate and deactivate the manual safety of the pistol.



In the «SAFE»-Position the safety lever is facing upward.



In the «FIRE»-Position the lever is facing forward (horizontally).

Magazine catch lever

By pressing the magazine release lever ⑫, the magazine can be removed. **NOTE:** The magazine catch lever can also be mounted on the right side (by a gunsmith).



⚠ WARNING Even if the magazine has been removed, there may still be a cartridge in the chamber! The pistol can fire even without inserted magazine!

Slide release lever (left side only)

The slide release lever ⑦ is used to lock the slide in its rear position (bolt open).



⚠ WARNING

If the slide is pulled back the hammer ⑤ is automatically cocked. If a filled magazine ⑭ is inserted, a cartridge will be automatically fed into the cartridge chamber as soon as the slide ④ is closed. In this case, the pistol is ready to fire! Always set the safety lever ⑧ to the «SAFE»-Position (as described above) after you have retracted the slide ④.

- When the inserted magazine ⑭ is empty, the magazine follower automatically actuates the slide catch lever and the slide ④ is locked in its rear position. ⇨

FUNCTION AND USE OF OPERATING CONTROLS continued

- To hold the slide open in case of no magazine ⑭ or a filled magazine inserted, retract the slide ④ all the way back until it stops, then push the slide release lever ⑦ upward to hold the slide open.
- To close the slide ④ in case of an empty magazine ⑭ inserted, pull back the slide ④ for some millimeters, push the slide release lever ⑦ downwards and release the slide ④. It will return to its fully forward position, driven by the force of the recoil spring.
- To close the slide ④ in case of no magazine or a filled magazine inserted, push the slide release lever ⑦ downwards. The slide ④ will return to its fully forward position, driven by the force of the recoil spring.

Trigger

When activated by the operator, the trigger ⑪ initiates the firing sequence. Located inside the frame, the trigger ⑪ when pulled with the firearm loaded and safety lever ⑧ in «FIRE»-Position will fire the gun (one round each time the trigger is pulled).



WARNING

Keep your finger off the trigger and outside the trigger guard until you are ready to fire.

SAFETY CHECK (CLEARING) BEFORE AND AFTER ANY USE



WARNING

The following safety check (clearing) MUST BE PERFORMED BEFORE AND AFTER ANY HANDLING/MANIPULATION/TRANSFER/STORAGE OR OTHER USE OF THE PISTOL. DURING THE ENTIRE SAFETY TEST, THE BARREL MUST POINT IN A SAFE DIRECTION.

- 1 Press the magazine release lever ⑫ (located on the left side of the pistol) and take out the magazine ⑭. CAUTION: Do not drop the magazine on the floor to avoid damage to the magazine lips!
- 2 Fully retract the slide ④ and lock it in its rear position by pushing up the slide release lever ⑦. Catch any ejected cartridge.
- 3 Engage the safety by turning the safety lever ⑧ upward into its «SAFE»-Position.
- 4 Visually check that there is no cartridge in the cartridge chamber of the barrel.
- 5 Press the slide release lever ⑦ or slightly retract the slide ④, to unlock it. Release the slide ④ and let it snap forward into its fully closed position.



ATTENTION

DANGER OF INJURY DUE TO THE FORWARD MOVING SLIDE! KEEP YOUR FINGERS AWAY FROM THE SLIDE ④ AND OUT

OF THE EJECTION PORT.

- 6 Disengage the safety by turning the safety lever ⑧ downwards into its «FIRE»-Position. While pointing the barrel in a safe direction fully pull the trigger ⑪ until the hammer ⑤ is released. THE PISTOL IS NOW EMPTY AND UNCOCKED!

FUNCTIONAL TEST OF THE PISTOL



WARNING

To ensure, that all parts and operating controls of the pistol such as frame, slide, trigger, and safety are working correctly, the following functional test must be performed before loading or shooting the pistol.

DURING THE ENTIRE FUNCTIONAL TEST, THE BARREL MUST POINT IN A SAFE DIRECTION. IF THE PISTOL FAILS ANY PART OF THE TEST, DON'T USE IT!

- 1 Perform a safety check (clearing) as described on page 22 to make sure, that the pistol is empty and uncocked (magazine removed, cartridge chamber free; hammer decocked).
- 2 Fully retract the slide ④ and release it. It must be returned to its fully forward position by the force of the recoil spring.
- 3 Engage the safety by turning the safety lever ⑧ upward into its «SAFE»-Position.
- 4 While safety engaged point muzzle in a safe direction. Pull the trigger ⑪. It must not be possible to pull the trigger and the hammer ⑤ **MUST NOT fall**.
- 5 Disengage the safety by turning the safety lever ⑧ downwards into its «FIRE»-Position. Point muzzle in a safe direction. Pull the trigger ⑪ AND HOLD IT IN ITS FULLY PULLED POSITION. The hammer ⑤ **MUST fall**.

CAUTION!

Always prevent dry firing of the pistol. Dry firing can lead to premature wear of the hammer ⑤ and/or the firing pin. Use your thumb to prevent the hammer ⑤ from snapping forward (let it move forward slowly and smoothly).

- 6 While still holding the trigger ⑪ in its fully pulled position, fully retract the slide ④ and release it. It must be returned to its fully forward position by the force of the recoil spring and the hammer ⑤ **MUST be cocked**.
- 7 Now slowly (!) release the trigger ⑪. A clear «CLICK» must be heard. The hammer ⑤ **MUST NOT FALL**.
- 8 Fully release the trigger ⑪. Point muzzle in a safe direction. Pull the trigger ⑪. The hammer ⑤ **MUST FALL**.
- 9 Insert an EMPTY magazine ⑭.
- 10 Retract the slide ④ until stop. The slide ④ must be locked in its rear position by the slide catch (open ejection port).
- 11 Push slide release lever ⑦ downward while pulling back the slide ④ some millimeters. After releasing the slide ④ must be returned to its fully forward position by the force of the recoil spring.
- 12 Retract the slide ④ until stop. The slide ④ must be kept in the rear position by the slide catch (open ejection port).
- 13 Remove the magazine ⑭ by pressing the magazine release lever ⑫.
- 14 Push the slide release lever ⑦. The slide ④ must be returned to its fully forward position by the force of the recoil spring.
- 15 Point muzzle in a safe direction. Pull the trigger ⑪. The hammer ⑤ **MUST FALL. THE PISTOL IS NOW EMPTY AND UNCOCKED!**

Functional test of the smooth operation of the firing pin

- 1 Perform a safety check (clearing) as described on page 22 to make sure, that the pistol is unloaded and uncocked (magazine removed, cartridge chamber free; hammer decocked). **Then disassemble the pistol as described on page 33.**
- 2 Remove first the recoil spring and second the barrel out of the slide (see page 33).
- 3 Take the slide in one hand, bottom up. **Push the firing pin entirely forward** by means of the cleaning bar or a mandrel. **The firing pin MUST MOVE AND MUST BE visible on the face of the slide** (protrusion approximately 2 mm, as shown on the photo).
- 4 **Release the pressure on the end of the firing pin. The firing pin MUST move back smoothly** into its initial position.

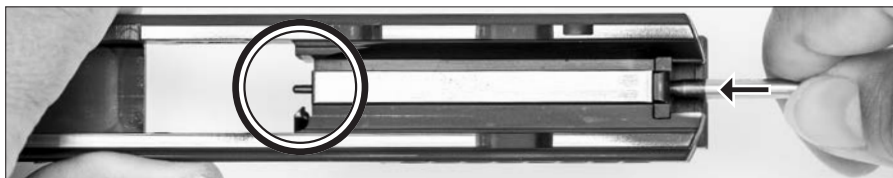

CAUTION!

If the firing pin is sluggish or if its protrusion is too small, the firing pin and the firing pin hole in the slide must be cleaned.

Disassembly of the firing pin

CAUTION

Dangerous spring tension!
Wear eye protection!

- **The firing pin is under spring tension! Press and hold the firing pin securely down with the mandrel or your thumb! Wear eye protection!**

- 1 Press down the firing pin by means of a fine mandrel and push out the firing pin retaining plate approx. 2 millimetres of the slide (photo «A»). Hold it in its position and securely press down the firing pin by means of the mandrel or your thumb. Completely remove the firing pin retaining plate and take out the firing pin (photos «B» and «C»).

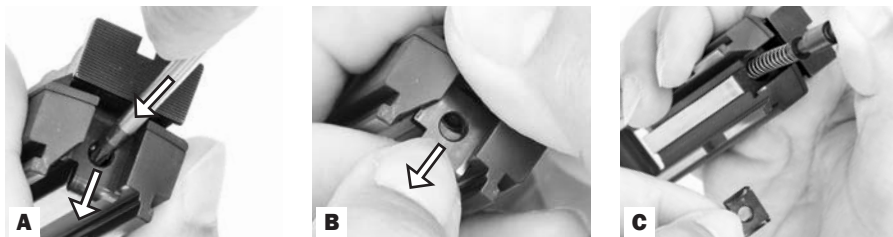

Cleaning of the firing pin

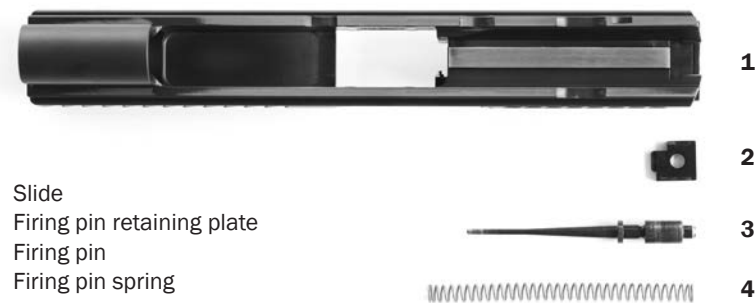

- 1 Slide
- 2 Firing pin retaining plate
- 3 Firing pin
- 4 Firing pin spring

- 1 Take out the firing pin (see page 24) and remove the spring from the firing pin.
- 2 Thoroughly clean the firing pin, the firing pin retaining plate, and the spring by means of gun cleaner and a brush. **ATTENTION:** Do not use aggressive agents or cloths with abrasive or scratching properties!
- 3 Thoroughly clean the firing pin hole in the slide by means of gun cleaner and a brush.
- 4 Slightly lubricate the firing pin, the firing pin spring, and the firing pin hole in the slide.

Reassembly of the firing pin



CAUTION

Dangerous spring tension!
Wear eye protection!

- **The firing pin is under spring tension! Press and hold the firing pin securely down with the mandrel! Wear eye protection!**

- 1 Install the spring on the firing pin and insert both together (conical tip ahead) into the firing pin hole in the slide. Then press down the firing pin by means of a fine mandrel (photo «A»).
- 2 Insert the firing pin retaining plate – wide part forward and L-shaped cut-out on the left – into its guide grooves in the slide (photo «B»). Make sure that the firing pin locks in place and engages fully into the hole of the firing pin retaining plate (photo «C»).

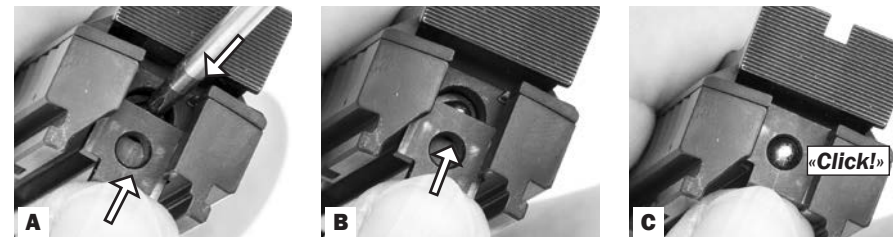

HANDLING AND OPERATION OF THE PISTOL

WARNING

• **THE FAILURE TO FOLLOW THE FOLLOWING FIREARM SAFETY REQUIREMENTS WILL CAUSE SERIOUS PERSONAL INJURY OR DEATH TO YOU OR OTHERS:**

- **ALWAYS TREAT ALL FIREARMS AS IF THEY ARE LOADED.**
- **ALWAYS BE SURE THAT THE BORE IS DRY, CLEAN AND FREE OF OBSTACLES.**
- **ALWAYS KEEP EYES, EARS, FINGERS, AND OTHER BODY PARTS AWAY FROM THE MUZZLE, THE MOVING SLIDE AND OUT OF THE EJECTION PORT.**
- **ALWAYS WEAR ADEQUATE AND PROPER EYE AND HEARING PROTECTION SPECIFIED FOR FIREARM USE** to prevent permanent damage to your eyes and hearing. Make sure others who are nearby are wearing eye and hearing protection as well. Safety glasses should protect your eyes from the firing flash and particles associated with the discharge of ammunition. Failure to do so creates a risk of personal injury from particle or debris spitting or from a ricochet.
- **ALWAYS BE ALERT AND NEVER USE ALCOHOL OR DRUGS BEFORE OR WHILE SHOOTING OR HANDLING ANY FIREARM.** Never shoot if you are tired, cold, or impaired in any way.
- **ALWAYS BE AWARE OF OTHER PEOPLE** so that persons do not accidentally walk into the line of fire and that persons nearby are not within an area where they may be struck by a ricochet or particles spitting from a firearm, or by ejected cases from some types of firearms.
- **NEVER SHOOT AT SURFACES THAT MAY CAUSE A RICOCHET AND NEVER FIRE RANDOMLY INTO THE SKY.** Always select a place to shoot that has a safe backstop, is free from obstructions and has no surfaces that may cause a ricochet.

Shooting in special climatic conditions

CAUTION!

In principle, the pistol works in any weather and at temperatures from -25°C to $+50^{\circ}\text{C}$. In order to avoid disturbances caused by freezing condensation water, the pistol should not be repeatedly moved from cold to warm and shortly afterwards back to cold. At temperatures below -25°C all moving parts should be treated with special oil for cold conditions. In very dusty environments and extreme heat, the lubrication points of the slide and all functional parts should be cleaned/oiled more often to minimize malfunctions.

DANGER

DO NOT FIRE THE PISTOL IF WATER IS PRESENT IN THE BARREL. Excess pressure can cause the weapon to explode.

ALWAYS drain any water from barrel prior to firing and dry the bore with a swab and cleaning rod if wet.

WARNING

ALWAYS TAKE OFF YOUR GLOVES WHEN SHOOTING THE PISTOL. The trigger guard is NOT designed to allow the use of gloves! Accidental discharges are possible when inserting gloved fingers into Trigger Guard area!

Preparing the pistol for shooting

- 1 **Perform a safety check (clearing)** as described on page 22.
- 2 Remove all oil from the bore by using a dry cleaning rod and check that the barrel is free of obstructions.
- 3 Perform a functional test as described on page 23 to check the pistol for proper condition and functioning.
- 4 Inspect any accessories mounted on the weapon for secure positioning.

Filling the magazine

- 1 Hold the magazine firmly with one hand.
- 2 With the fingers of your other hand place a cartridge, projectile facing the front of the magazine, onto the follower and push it, with your thumb, first down, underneath the magazine lips and then fully to the rear.
- 3 Repeat this step until magazine is filled.

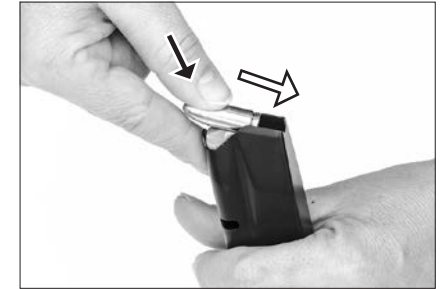

WARNING

• **Ensure that all loaded cartridges are clean, dry, new, undamaged and of the correct caliber (see page 10 ff).**

- **ONLY USE ORIGINAL MAGAZINES** made by PHX PHOENIX AG. These magazines are designed to operate in your specific model of pistol.
- **DO NOT USE** the magazines of your pistol in any other firearm! Also, when it may be able to insert them into another model firearm, the magazines will only function properly in the specific model for which they are designed. Do not interchange magazines from one model firearm to another model firearm.
- **Follow instructions in this manual and any other specific instructions which may be marked onto, or accompany, a magazine.** Failure to use the particular type of PHX PHOENIX AG magazine specified for your model and caliber of firearm may result in a malfunction.

CAUTION!

Risk of material damage due to overfilled magazines and/or permanently filled magazines. To avoid damage to the magazine spring, malfunctions and other troubles, magazines must only be filled up to the maximum number of cartridges indicated on the magazine and MUST be emptied after shooting and during storage.

Loading the pistol

WARNING

- **Always point the muzzle in a safe direction!**
- **Don't load the pistol until you have completely read and fully understand this operator's manual.**

⚠ WARNING

- Do not load the pistol until you are ready to use it.
 - Keep your finger off the trigger and outside the trigger guard until you are ready to fire (you are sure of your target and the sights are aiming at the target).
 - Do not carry the pistol with the slide open and a loaded magazine inserted. An accidental discharge may result if the slide closes and the safety lever is not in the «SAFE»-Position.
- 1 Hold the pistol at the grip and point the muzzle in a safe direction.
 - 2 **Insert the filled magazine into the magazine well and push it up until the magazine release is engaged («Click!»).** Ensure that the magazine properly locks into place («tap and pull»). The pistol is «partially loaded».
 - 3 **When the slide was open prior to insertion of the filled magazine:** Push slide release lever ⑦ downward to close the slide ④.
 - 4 **When the slide was closed prior to insertion of the filled magazine:** Fully retract the slide until stop (the hammer gets cocked) and release it.
 - 5 By sliding forward in its fully closed position the slide chambers the first cartridge from the magazine into the cartridge chamber. **The pistol is now «loaded and cocked».**
 - 6 Turn the safety lever ⑧ upward into its «SAFE»-Position. **The pistol now is «loaded, cocked and safe».**

⚠ WARNING

- When the pistol is «loaded and cocked» it will fire immediately when the trigger is pulled.
- When the pistol is «loaded, cocked and safe» it will fire if the safety lever ⑧ is set to the «FIRE»-Position and the trigger is pulled.
- When the pistol is «loaded and cocked» an accidental discharge may result when the pistol is dropped or receives a blow or a hit to its muzzle or front. This can occur regardless of the position of the safety lever and other safety devices. Therefore, extra care and strict adherence by the user to these instructions is mandatory for minimizing the risk of accidents.
- Always point the muzzle in a safe direction when you release the slide.
- Keep your fingers away from the slide, the ejection port, and the muzzle.
- If, during loading procedure, the cartridge fails to strip from the magazine or fully seat into the chamber, immediately stop the loading process, point the muzzle in a safe direction and clear the weapon (refer to page 22). After clearing refer to the chapter «Malfunctions and errors, cause and elimination» of this OM and perform a «Functional Test» (refer to page 23) to make sure, that the pistol is in perfect conditions before you retry to load it.
- NEVER attempt to load the pistol by inserting a round (cartridge) into the open ejection port. ALWAYS load the weapon by feeding it from the magazine.
- NEVER strike or drop the pistol. An accidental discharge may result if the slide closes and the safety lever is not in the «SAFE»-Position.
- The pistol can fire without magazine. Keep your fingers off the trigger and outside the trigger guard until you have made the commitment to fire.

NOTICE**Loaded chamber indicator**

If a cartridge is loaded into the cartridge chamber the loaded chamber indicator of the pistol is engaged (slightly raised) and can be felt with the fingertip. Additionally, the base of the cartridge is visible between the slide and the breech.

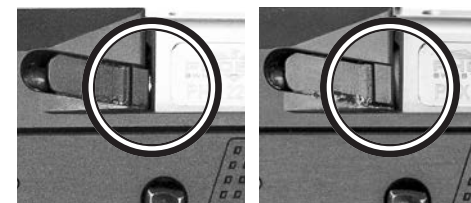

Pistol unloaded

Pistol loaded

Firing the pistol

⚠ WARNING

- **RISK OF INJURY DUE TO LACK OF KNOWLEDGE OF THE CORRECT SHOOTING TECHNIQUE!** This manual explains how the pistol works and how it is operated. However, it DOES NOT IN ANY WAY replace the training necessary for safe shooting. If you have not completed such training, do so before you start shooting!
- **SHOOTING IS NOT A GAME!** Once a projectile is fired, no one can ever retrieve it! Always act in accordance with the four basic safety rules of shooting:
 - 1 Always treat all firearms as if they are loaded.
 - 2 Never point the pistol at something you do not want to hit/destroy. Always point the muzzle in a safe direction
 - 3 Keep your finger off the trigger and out of the trigger guard until you are ready to fire (sighting devices aiming at the target)
 - 4 Be sure of your target. Only shoot when it is absolutely certain that the desired target is being aimed (without any doubt!) and that no unintentional danger for the shooter, other persons, animals, etc. can arise from a shot.
- **RISK OF INJURY DUE TO «COOK OFF»!** Sustained firing can create excessive heat in the barrel and can cause «cook-off» of ammunition (heat-firing of the cartridge in the chamber). This can occur a substantial period of time after firing has ceased. Therefore, ALWAYS UNLOAD THE FIREARM AND UNLOAD THE CHAMBER IMMEDIATELY AFTER YOU HAVE FINISHED SHOOTING!
- The recoil of the pistol can cause severe injuries. Hold the pistol firmly when shooting and keep your eyes at least 4 inches away from the sight!
- Keep face, ears, eyes, hands, and fingers away from the slide, the ejection port (hot gases and brass are ejected) and from the muzzle when firing. The slide of the pistol automatically opens and shuts very quickly while firing.
- Always wear eye and hearing protection specified for firearm use every time you use the pistol and make sure, that bystanders are doing so as well.

Firing in single action mode

- 1 **Load the pistol** (see pages 27 to 29) and **engage the safety** by turning the safety lever ⑧ upward into its «SAFE»-Position. **The pistol is «loaded, cocked and safe».**
- 2 Firmly hold the pistol in the shooting hand and in the shooting position.
- 3 **Align the front and rear sights of the pistol toward your intended target.**
- 4 **Disengage the safety** by turning the safety lever ⑧ downwards («FIRE»-Position).
- 5 While keeping the muzzle pointed on the intended target **slowly pull the trigger** ⑪ until the cocked hammer ⑤ is released and the cartridge in the cartridge chamber is ignited by the firing pin. **The pistol fires!**

 **WARNING** THE FIREARM RELOADS AUTOMATICALLY! The PHOENIX PREDATOR pistol is a semi-automatic recoil loader and reloads automatically after each shot (as long as there are cartridges in the magazine). So, it is ready to fire again immediately after each shot! **KEEP THE MUZZLE ALWAYS POINTED IN A SAFE DIRECTION!**

- 6 After you have fired the first round of the magazine ⑭, you may **continue to fire** by pulling and fully releasing the trigger ⑪ until the magazine is empty. The pistol will fire one round each time the trigger ⑪ is pulled.
- 7 If you have fired the last round from the magazine ⑭, the slide ④ automatically will be locked open by the bolt catch lever. By this the pistol can quickly be reloaded by replacing the empty magazine ⑭ (see page 31). Also, the cartridge chamber can be inspected immediately and easy to ensure that it is empty.
- 8 If you wish to **stop firing before the magazine is empty**, keep the muzzle pointing in a safe direction, fully release the trigger, remove finger from trigger guard and turn the safety lever ⑧ upward to the «SAFE»-Position. Remove the magazine ⑭ by pressing the magazine release lever ⑫. **Perform a safety check (clearing;** see page 22).

Firing in double action mode

NOTICE: Firing the pistol in **double action mode** means that the pistol is loaded (chambered cartridge), but the hammer is uncocked before firing.

- 1 **Load the pistol** (see pages 27 to 29) so that it is «loaded, cocked and safe».
- 2 Firmly hold the pistol in the shooting hand and in the shooting position.
- 3 **Disengage the safety** by turning the safety lever ⑧ downwards into its «FIRE»-Position. Firmly hold the cocked hammer ⑤ with the thumb of the other hand, pull the trigger ⑪ and let the hammer ⑤ move forward slowly and controlled. **The pistol is now «loaded, uncocked and ready to fire».**
- 4 **Align the front and rear sights of the pistol toward your intended target.**
- 5 If you are sure of your target, **slowly pull the trigger** ⑪. By doing this, the hammer ⑤ first is cocked and then released and the cartridge in the cartridge chamber is ignited by the firing pin. **The pistol fires!**

**WARNING****Danger of negligent discharge (unintended firing)!**

- **After firing a shot in the double action mode, the pistol is automatically reloaded, and the hammer is automatically cocked! The trigger then reacts much more sensitively and the pistol shoots in single action mode!**

Reloading the pistol when magazine is empty

NOTICE: After firing the last round from the inserted magazine ⑭, the slide release catches the slide ④ and holds it open (locked in its rear position). **The hammer is cocked!**

- 1 **Point the muzzle in a safe direction.**
- 2 **Engage the safety** by turning the safety lever ⑧ upward into its «SAFE»-Position.
- 3 **Press the magazine release lever** ⑫ and remove the empty magazine.
- 4 **Insert a filled magazine** into the magazine well until magazine release is engaged («Click!»). Ensure that the magazine properly locks into place («tap and pull»).
- 5 **Push the slide release lever** ⑦ downward **OR slightly retract the slide and release it.** The slide will snap forward into its fully closed position. By this the first cartridge from the new magazine is transported into the cartridge chamber.
- 6 **The pistol is «loaded, cocked and safe».**

Reloading the pistol when magazine is NOT empty

NOTICE: As long as cartridges are present in the inserted magazine ⑭, the slide ④ moves automatically to its fully forward position after each shot (closed slide), **a live round is present in the cartridge chamber of the barrel and the hammer is cocked! That means, the weapon is «loaded and cocked»!**

**WARNING**

- **When the pistol is «loaded and cocked» it will fire immediately when the trigger is pulled.**
- **The pistol can fire without a magazine inserted.**
- **Keep your fingers off the trigger and outside the trigger guard and the muzzle pointing in a safe direction!**

- 1 **Point the muzzle in a safe direction.**
- 2 **Engage the safety** by turning the safety lever ⑧ upward into its «SAFE»-Position.
- 3 **Press the magazine release lever** ⑫ and **remove the partially filled magazine.**
- 4 **Insert a new (filled) magazine** into the magazine well until magazine release is engaged («Click!»). Ensure that the magazine properly locks into place («tap and pull»).
- 5 **The pistol is «loaded, cocked and safe».**

Unloading the pistol when magazine is NOT empty

NOTICE: As long as cartridges are present in the magazine (14), after each shot (closed slide) a live round is present in the cartridge chamber and the hammer is cocked! This means, the weapon is «loaded and cocked»!

WARNING

• When the pistol is «loaded and cocked» it will fire immediately when the trigger is pulled.

- The pistol can fire without a magazine inserted.
- Keep your fingers off the trigger and outside the trigger guard and the muzzle pointing in a safe direction!

- 1 Point the muzzle in a safe direction.
- 2 Press the magazine release lever (12) and remove the partially filled magazine.
- 3 Fully retract the slide and catch and collect the ejected cartridge.
- 4 Push the slide release lever upward to lock the slide in its rear position.
- 5 Visually check that there is no cartridge in the cartridge chamber of the barrel.
- 6 Push the slide release lever (7) downward OR slightly retract the slide (4) and release it. The slide will snap forward into its fully closed position.
- 7 Point muzzle in a safe direction and pull the trigger (11) until the hammer falls. The pistol is now «unloaded and disengaged».

Unloading the pistol when magazine is empty

NOTICE: After firing the last round from the inserted magazine (14), the slide release catches the slide (4) and holds it open (locked in its rear position). The hammer is cocked!

- 1 Point the muzzle in a safe direction.
- 2 Engage the safety by turning the safety lever (8) upward into its «SAFE»-Position.
- 3 Press the magazine release lever (12) and remove the empty magazine.
- 4 Visually check that there is no cartridge in the cartridge chamber of the barrel.
- 5 Push the slide release lever (7) downward OR slightly retract the slide (4) and release it. The slide will snap forward into its fully closed position.
- 6 Point muzzle in a safe direction, disengage the safety by turning the safety lever (8) downwards into its «FIRE»-Position and pull the trigger (11) until the hammer falls. The pistol is now «unloaded and disengaged».

Unloading a NOT empty magazine

Hold the magazine with one hand. Carefully push the cartridges forward out of the magazine with the thumb of the other hand and collect all of them.

WARNING

Don't let the cartridges drop on a hard surface. Don't unload cartridges using another cartridge or any tools!

DISASSEMBLY OF THE PISTOL

WARNING

• Always unload and clear the pistol (as described on page 22) before cleaning, lubrication or disassembly.

- Do not use any tools or any force for disassembling or assembling of the pistol.
- The pistol MUST NOT be disassembled further than described below.
- NEVER alter or modify the parts of the pistol.
- Wear safety glasses that are specified for firearms use when disassembling or assembling the pistol.

- 1 Perform a complete safety check to unload and clear the pistol (refer to page 22).
- 2 Hold the pistol with one hand and push the slide (4) some millimeters to the rear until the index lines of the slide and the frame meet each other (photo «A»).
- 3 With the other hand press in the axle of the slide release lever (7) from the right (photo «B») and pull out the slide release lever (7) to the left (photo «C»).
- 4 Pull the trigger (11) and remove slide (4) by sliding it forward off the frame (photo «D»).
- 5 Turn the slide «bottom up», depress the recoil spring slightly against the front to compress it and then lift it out of the slide (incl. its rod; photo «E»).
- 6 Take out the barrel (3) backward-upward (photo «F»).

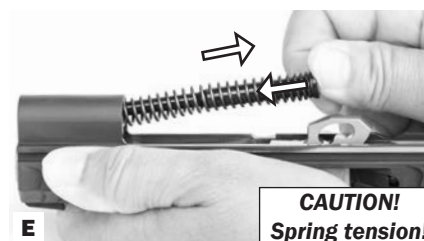
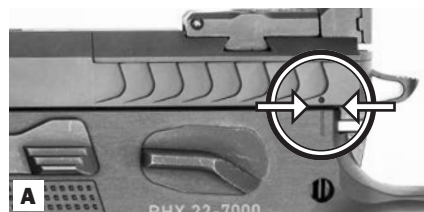

REASSEMBLY OF THE PISTOL

- 1 Insert the barrel ③ into the slide and move it backward until it locks with the slide (photo «A»).
- 2 Insert the recoil spring with its guide rod into the slide. Press the front end of the recoil spring guide against the pressure of the recoil spring through the hole provided in the front of the slide. Support the recoil spring retainer at the front of the shelf of the barrel (photo «B»).
- 3 Insert the frame from the rear into the guiding grooves of the slide ④ (photo «C») until the index lines of the slide and the frame meet (photo «D»).
- 4 Put the slide release lever ⑦ into its place from the left side of the frame (photo «E») and depress it until it engages properly (photo «F»).
- 5 Let the slide ④ glide into its fully forward position forced by the pressure of the recoil spring.

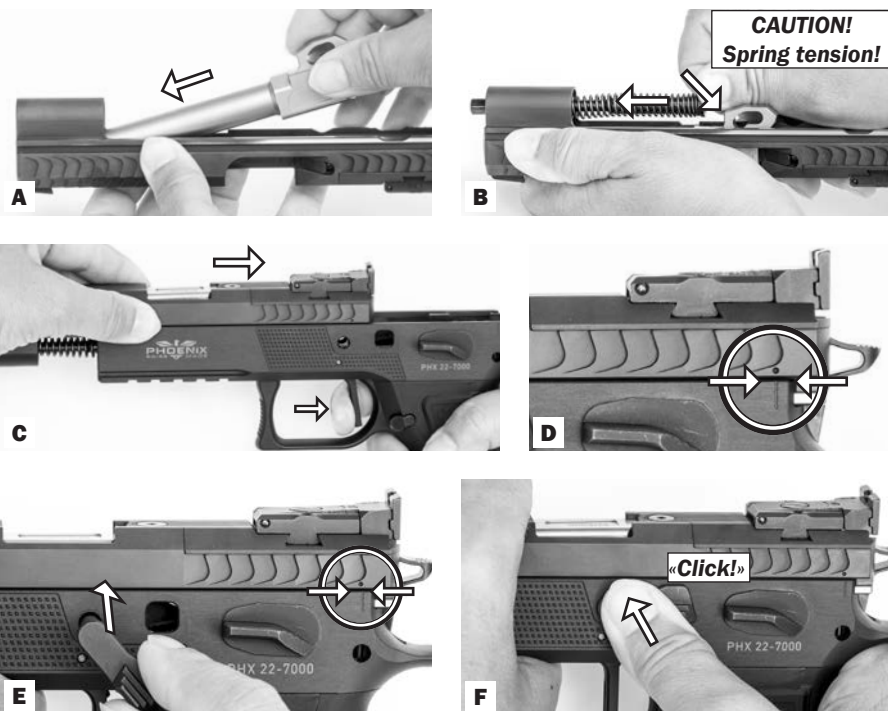

WARNING

Check the pistol! Work through functional test before use!

- After every dis- and reassembly a functional test (as described on page 23) **MUST** be performed. If the pistol fails in any part of the test, do not use it!

CLEANING AND CARE



WARNING

- Always unload and clear the pistol (as described on page 22) before cleaning, lubrication, or disassembly.
- Do not use any force for disassembling, cleaning, or assembling of the pistol.
- Wear safety glasses that are specified for firearms use when disassembling, cleaning, or assembling the pistol.
- NEVER manipulate, adjust, or change any of the parts of the pistol.
- Any maintenance, adjustment or service not specified in this manual **MUST** be performed by a qualified gunsmith using genuine parts from PHX PHOENIX AG.
- Always have adequate ventilation. Cleaning or discharging the pistol in poorly ventilated areas may result in exposure to lead and other substances known to cause birth defects, reproductive harm, and other serious physical injury. Wash hands thoroughly after exposure.

CAUTION!

Only use high-quality weapon care products and cleaning devices. Do not clean the pistol or its components in an ultrasonic bath. Do not use acids, alkali or chemical cleaning agents, hard metal objects or sharp, scraping, or abrasive materials for cleaning the pistol or its components.

For cleaning and care of the pistol the following materials and tools are necessary:

- PHX PHOENIX pistol cleaning kit (comes with the pistol; see page 17).
- Cleaning rods and rags, cleaning solvent and conserving agents without chlorine or acids.



Normal cleaning (after each shooting session)

- 1 Perform a safety check (see page 22) and **disassemble the pistol** (see page 33).
- 2 Clean fouled parts and surfaces on the frame and the slide with a cleaning brush, cleaning solvent and rags and then lubricate them lightly.
- 3 Moisten a cleaning brush with oil. Repeatedly pass it through the barrel. Then pass pure cleaning rods through. Finally lubricate the exterior and interior of the barrel.
- 4 Clean the magazine lips and follower.
- 5 **Reassemble the pistol** (see page 34) and **perform a functional test** (see page 23).

Major cleaning (after approx. 1000 rounds or once per year)

In addition to the normal cleaning perform the following steps.

- 1 Disassemble the magazine (see page 36) and clean the inside of the magazine housing and the external surfaces of the follower.
- 2 Check the firing pin (see page 24) and clean firing pin hole inside the slide.
- 3 **Reassemble the pistol** (see page 34) and **perform a functional test** (see page 23).

MAGAZINES



WARNING

The magazine spring is under pressure. Control the spring and the floor plate retainer, so that they do not fly out and cause injury. Wear safety glasses that are specified for firearms use when disassembling, cleaning, or assembling the magazines of the pistol.

Magazines

1 Magazine complete

Magazine disassembled

- 2 Magazine floor plate
- 3 Magazine housing
- 4 Follower
- 5 Magazine spring (with locking plate)

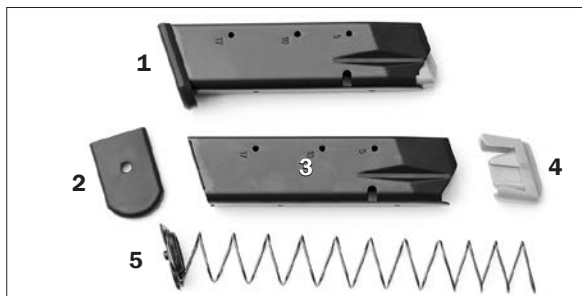

Disassembly of the magazine

- 1 Using a small, blunt object (such as an Allen wrench), push the floor plate retainer down by passing the tool through the hole in the floor plate.
- 2 Push the magazine floor plate forward while firmly holding the floor plate retainer!
- 3 Remove the floor plate, release the magazine spring, remove the spring and the follower. Clean the magazine housing (in- and outside), the spring and the follower with a cloth.

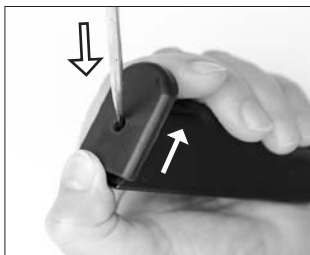

CAUTION!

DO NOT oil the magazine! Oily cartridges lead to increased contamination and can provoke premature wear of the weapon and/or malfunctions! **Magazines with worn magazine lips MUST be replaced.**

Reassembly of the magazine

- Insert the follower and the magazine spring into the housing. Depress the magazine spring. Push the magazine floor backward until it engages with the locking plate.



WARNING

RISK OF INJURY OR DEATH DUE TO INCORRECTLY MOUNTED WEAPON/COMPONENTS! AFTER EVERY FULL OR PARTIALLY DISASSEMBLY/ASSEMBLY OR CLEANING OF THE PISTOL A FUNCTIONAL CHECK (as described on page 23) MUST BE CARRIED OUT! IF THE WEAPON FAILS IN ANY PART OF THE FUNCTIONAL TEST, DON'T USE IT!

SIGHTS OF THE PISTOL



- The sights of the PHOENIX PREDATOR STANDARD consist of a rear sight («1») and a front sight («2»). Both components are available in different variants (see page 18).
- The front sight is fixed by a screw. The rear sight is mounted on a mounting plate.
- The rear sight is adjustable in windage and elevation by the aid of click screws («a» and «b»), allowing to compensate for both horizontal and vertical deviations in the shot group.

High shot	Low shot	Left shot	Right shot
Rotate screw «b» clockwise	Rotate screw «b» counter clockwise	Rotate screw «a» clockwise	Rotate screw «a» counter clockwise

CAUTION!

Improper manipulations can cause damage!

- **Any necessary corrections to the mounting of the open steel sights of the PHOENIX PREDATOR STANDARD pistol (e.g., lateral drifting of the rear sight, mounting of a front sight of a different height, etc.) should in principle be carried out by the gun mechanic, gunsmith or another appropriately skilled person, as special tools are required for this purpose.**
- **For the adjustment of the red dot sight mounted on the PHOENIX PREDATOR «CARRY OPTIC» models, please refer to the manual of the manufacturer of the red dot sight.**

CHANGE BETWEEN SIGHTS AND OPTICS

The PHOENIX PREDATOR pistol is equipped with a «quick change» mounting plate to allow the simple and fast change between the open sights (model STANDARD) and the red dot sight (model «CARRY OPTIC» – and vice versa. The mounting plate is guided in a groove and secured at the front by a screw. At its rear it is supported against the firing pin retaining plate (also see pages 24 and 25).

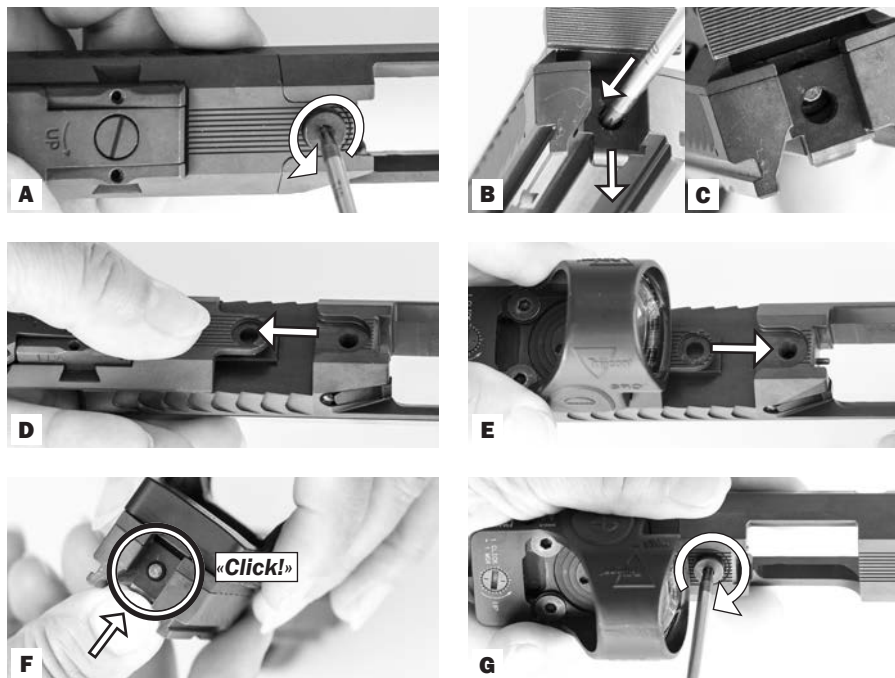

- 1 Perform a complete safety check to unload and clear the pistol (refer to page 22).
- 2 Disassemble the pistol (see page 33) or fully retract the slide ④ and push the slide release lever ⑦ upward to lock the slide in its rear position.
- 3 Loosen the Torx screw of the quick change mounting plate (photo «A»).
- 4 Press down the firing pin retaining plate by means of a fine mandrel and slide downward the firing pin retaining plate approx. 2 millimeters (photo «B» and «C»; see also page 24).
- 5 Pull the mounting plate with the rear sight backwards and off the bolt (photo «D»).
- 6 Place the groove of the mounting plate with the red dot sight from the rear on the guide rail of the slide and push the plate completely forward (photo «E»).
- 7 Fully slide upward the firing pin retaining plate. Make sure that the firing pin locks in place and engages fully into the hole of its retaining plate (photo «F»; see page 25).
- 8 Insert and fix the Torx screw of the quick-release plate (photo «G»).

The change back from the red dot sight to the open sight is carried out in the reverse order in the identical manner.

CHANGING THE GRIP PANEL

PHOENIX PREDATOR STANDARD and «CARRY OPTIC» pistols are equipped with an **exchangeable grip panel** ⑬. Various grip panel models made of polymer material or aluminum allow an individual adaptation of the pistol to your visual and haptic preferences respectively your individual needs.

Changing the grip panel

- 1 Perform a complete safety check to unload and clear the pistol (refer to page 22).
- 2 Make sure that there is no magazine (even an empty one) inserted into the magazine well.
- 3 Place the left side of the gun on a firm, non-slippery and non-scratching surface (preferably a teflon working plate, or – if such a plate is not available – a wooden block).
- 4 Use a blunt (!) mandrel to push or carefully tap out the retaining pin at the lower rear end of the grip panel ⑬ (photo «A») from right to left.
- 5 After removing the retaining pin, the grip panel ⑬ can be pulled backwards off the lower part of the frame (photo «B»).
- 6 Push the new grip panel ⑬ onto the lower part of the frame from behind (photo «C»).
- 7 Insert the retaining pin into its bore from the left side and press or tap it in gently (!) until it is centered and does not protrude beyond the grip panel ⑬ on any side of the gun (photo «D»).

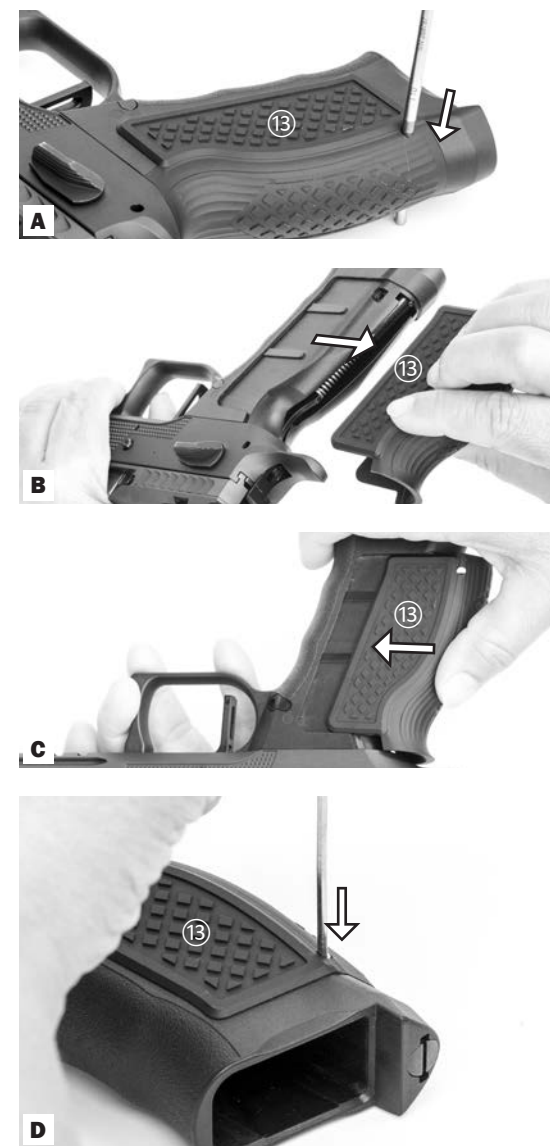

MALFUNCTIONS AND ERRORS, CAUSE AND ELIMINATION

WARNING

- Always point the muzzle in a safe direction
 - Wear eye and hearing protection specified for use with firearms when firing and clearing misfires or misfeeds.
- 1 **IF YOUR PISTOL GIVES ANY INDICATION THAT IT IS NOT PERFORMING PROPERLY OR THE OPERATION OF YOUR PISTOL HAS CHANGED «THE WAY IT FEELS OR SOUNDS», IMMEDIATELY STOP FIRING.** Unload and clear the weapon (see page 22) and check for unburned powder grains in the chamber or the bore as well as for a bullet stuck in the bore. Clean out any unburned powder before resuming firing.
 - 2 **IF YOU HAVE ANY DOUBT ABOUT THE CONDITION OF THE PISTOL STOP SHOOTING IMMEDIATELY AND GET THE PISTOL PROFESSIONALLY REPAIRED BY A GUNSMITH QUALIFIED TO PERFORM SERVICE ON FIREARMS MADE BY PHX PHOENIX AG!**

Clearing a misfire

- 1 If a cartridge fails to fire, **stop shooting immediately.**
- 2 **Keep the muzzle pointed in a safe direction,** take your finger off the trigger ⑪ and out of the trigger guard, **engage the safety** by turning the safety lever ⑧ upward into its «SAFE»-Position and **wait at least 30 seconds.**
- 3 **Press the magazine release button ⑫ and remove the magazine.**
- 4 **Fully retract the slide ④** (the defective cartridge should be extracted and ejected) and push the slide release lever ⑧ upward to lock the slide in its open position.
- 5 **Visually check** that there is no cartridge in the cartridge chamber of the barrel.

Clearing a misfeed («JAM»)

NOTICE: Any self-loading firearm may, on occasion, fail to feed a cartridge properly from the magazine. If this should occur:

- 1 If a cartridge is not correctly feed into the chamber, **stop shooting immediately.**
- 2 **Keep the muzzle pointed in a safe direction** and take your finger off the trigger ⑪ and out of the trigger guard
- 3 **Engage the safety** by turning the safety lever ⑧ upward into its «SAFE»-Position.
- 4 **Press the magazine release button ⑫ and remove the magazine.**
- 5 **Fully retract the slide ④** (this should allow clearance for the jammed cartridge to fall free and clear of the firearm) and push the slide release lever ⑧ upward to lock the slide in its open position.
- 6 **Visually check to make sure all cartridges have been removed from the weapon.**
- 7 **If it is necessary to manually remove a jammed cartridge,** use only wooden «tools» and **use extreme care to avoid striking the primer of the cartridge.**
- 8 **Safely dispose all cartridges involved in a misfeed incident. Do not use damaged ammunition in any firearm!** Dispose of defective cartridge(s) in a method specifically approved for live round disposal.

Clearing a misfeed («JAM»)

continued

WARNING

- **Keep your face at a safe distance from the ejection port when clearing a misfeed cartridge. A cartridge may ignite if the primer of the cartridge is struck with sufficient force. If the cartridge ignites while being cleared from the pistol, death or serious injury may result!**
 - **If you are in any doubt, how to clear a misfeed, don't act by yourself and get the weapon professionally repaired.**
- 9 **Unload/clear the weapon** by performing a safety check (as described on page 22).
 - 10 **Inspect pistol, magazine and ammunition** for dirt or debris and clean it.
 - 11 **Perform a functional test of the pistol (as described on page 23) to make sure, that the pistol is in perfect condition, before you try to load it again (as described on page 27–29).**
 - 12 **IF YOU HAVE ANY DOUBT ABOUT THE CONDITION OF THE FIREARM STOP SHOOTING IMMEDIATELY AND GET THE FIREARM PROFESSIONALLY REPAIRED!**

Clearing a bullet stuck in the bore

WARNING

- **IF AN AUDIBLE «POP» OR REDUCED RECOIL IS EXPERIENCED DURING FIRING, IMMEDIATELY CEASE FIRE!**
- A bullet may stuck in the bore! THIS IS AN EXTREMELY DANGEROUS SITUATION BECAUSE FIRING THE PISTOL WITH ANY OBSTRUCTION IN THE BORE MAY RESULT IN SEVERE DAMAGE TO THE WEAPON AND SERIOUS INJURY OR DEATH TO THE SHOOTER AND OTHER PERSONS NEARBY.**

- 1 **Stop shooting immediately, keep the muzzle pointed in a safe direction, take your finger off the trigger ⑪ and out of the trigger guard and engage the safety** by turning the safety lever ⑧ upward into its «SAFE»-Position.
- 2 **Press the magazine release button ⑫ and remove the magazine.**
- 3 **Fully retract the slide ④** (the defective cartridge should be extracted and ejected) and push the slide release lever ⑧ upward to lock the slide in its open position.
- 4 **Visually check to make sure all cartridges have been removed from the weapon.**
- 5 **Unload/clear the weapon** by performing a safety check (as described on page 22).
- 6 Remove the slide ④ from the frame of the pistol (see «Disassembly of the pistol» page 33), remove first the recoil spring and then the barrel from the slide and check the barrel for a bullet or other obstructions stuck in the bore.

WARNING

- **IF A BULLET IS STUCK IN THE BORE, DO NOT TRY TO REMOVE IT! TAKE THE WEAPON TO A GUNSMITH QUALIFIED TO PERFORM SERVICE ON FIREARMS MADE BY PHX PHOENIX AG.**
- **NEVER TRY TO SHOOT OUT A BORE OBSTRUCTION! NEVER ATTEMPT TO REMOVE A LODGED BULLET USING A BLANK CARTRIDGE, OR A CARTRIDGE FROM WHICH THE BULLET HAS BEEN REMOVED, OR BY THE USE OF A CLEANING ROD AND FORCE APPLIED TO THE ROD.**

TROUBLE SHOOTING CHART



WARNING

• **RISK OF INJURY OR DEATH DUE TO NEGLIGENT DISCHARGE (unintended firing)! IN CASE OF ANY MALFUNCTION THE WEAPON MUST ALWAYS BE REGARDED AS LOADED!**

- **STOP SHOOTING IMMEDIATELY, KEEP MUZZLE POINTED IN A SAFE DIRECTION, UNLOAD AND CLEAR THE PISTOL (AS DESCRIBED ON PAGE 22)!**
- **Users are STRICTLY PROHIBITED from carrying out any further troubleshooting than that described below! Other malfunctions must be remedied by the manufacturer or by an authorized gunsmith.**

By means of regular maintenance (see page 40) and regular cleaning and care (see page 35) the functional safety and reliability of the pistol is kept on its highest level and the service life is increased. In case of malfunctions work through the following trouble shooting chart.

Malfunction	Cause(s)	What to do
Pistol won't fire	Pistol is «safe»	Turn safety lever to the «FIRE»-Position (see page 21)
	Defective ammunition	Point muzzle in a safe direction for at least 30 sec. Then unload the pistol. Insert fresh ammunition. If error occurs again: Unload/clear pistol (page 22) and return it for repair.
	Sluggish firing pin	Unload/clear pistol (page 22); check/clean firing pin (page 24/25)
	Damaged or broken firing pin	Replace the firing pin
	Defective hammer or hammer spring	Unload/clear pistol (page 22) and return it for repair
	Defective trigger or trigger system	Unload/clear pistol (page 22) and return it for repair
Cartridge not fed correctly	Magazine not correctly inserted	Insert magazine correctly (page 27/28)
	Damaged magazine or magazine lips	Replace the magazine
	Defective magazine spring	Replace the magazine spring
	Short recoil due to dry or dirty or broken recoil spring	Unload/clear and disassemble the pistol, check, clean and lubricate the recoil spring
Cartridge not properly chambered	Battered cartridge; wrong calibre	Use proper ammunition of the correct calibre
	Fouled cartridge chamber	Unload/clear pistol, clean chamber if necessary
	Defective recoil spring	Unload/clear and disassemble the weapon, check recoil spring, if necessary return weapon for repair

Malfunction	Cause(s)	What to do
Slide did not open after the shot.	Cartridge jams in the chamber because it is deformed or the chamber is fouled.	Pull back the slide and hold it open. If cartridge is not ejected take it out by hand. Unload/clear and disassemble pistol, clean chamber, inspect extractor. If necessary return pistol for repair.
	Badly loaded ammunition	Unload/clear the pistol. Check barrel on lodged bullet. Return pistol for repair if necessary.
Cartridge not ejected after the shot	Badly loaded ammunition	Unload/clear the pistol. Check barrel on lodged bullet. Return pistol for repair if necessary Use proper ammunition
	Insufficient slide recoil	Unload/clear the pistol. Pull back the slide and remove the cartridge. Check for smooth operation and clean the cartridge chamber if necessary
	Fouling or too much carbon in chamber	Unload/clear and disassemble the pistol, clean the chamber.
	Short recoil due to dry or dirty or broken recoil spring	Unload/clear and disassemble the pistol, check, clean and lubricate the recoil spring
	Damaged extractor, extractor spring or ejector	Unload/clear the pistol (page 22) and return it for repair
Slide does not stay open when magazine is shot empty	Defective magazine (magazine lips bent, broken or damaged; magazine spring weak or broken; follower defective)	Replace the magazine
	Insufficient slide recoil	Check for smooth operation and clean the cartridge chamber if necessary
	Damaged slide release lever or slide release spring	Unload/clear and disassemble the pistol, check the slide release. Return pistol for repair if necessary
Failure of magazine to lock in the pistol	Badly loaded ammunition	Unload/clear the pistol. Check barrel on lodged bullet. Return pistol for repair if necessary Use proper ammunition
	Defective magazine	Replace the magazine
Point of impact changes	Defective magazine catch	Unload/clear the pistol (page 22) and return it for repair
	Loose sight base or defective front or rear sight	Check sights and sight base. Fix and properly adjust the sights
	Loose or defective optical sight	Check optical sight and its base
	Change of type of ammunition.	Change back to previous ammunition type or readjust sights

LIST OF PARTS

Model PHOENIX PREDATOR STANDARD «SA only» with manual safety

- | | |
|---------------------------------------|-------------------------------------|
| 1 Upper frame | 67 Mainspring housing locking pin |
| 2 Lower frame | 68 Firing pin retaining plate |
| 3 Frame screws (set of 3) | 81 Mounting plate LPA |
| 4 Grip panels (Fusion Alu) | 110 Mounting plate screw |
| 5 Recoil buffer | 500 Magazine (17rds; complete) |
| 6 Slide | 600 Cleaning kit (not shown) |
| 7 Barrel (Standard; cal. 9 x 19 mm) | 700 Pistol bag (Cordura; not shown) |
| 8 Recoil spring guide | 800 Operator's manual (not shown) |
| 9 Recoil spring | 926 Cylinder pin 3x18 |
| 11 Front sight (H5.7) | 930 Cylinder pin 2.5x24 |
| 12 Rear sight (Standard OR LPA) | 953 Threaded pin M3x3 |
| 13 Firing pin | 970 Threaded pin M2.5x4 |
| 14 Firing pin spring | 971 Threaded pin M2.5x5 |
| 16 Extractor | |
| 17 Extractor plunger | |
| 18 Extractor spring | |
| 21 Ejector | |
| 22 Sear | |
| 24 Sear spring | |
| 28 Trigger bar | |
| 29 Trigger spring | |
| 31 Trigger bar pin | |
| 32 Magazine release | |
| 33 Magazine release spring | |
| 34 Magazine release plunger | |
| 35 Magazine release screw | |
| 36 Trigger bar spring | |
| 37 Slide release (left) | |
| 38 Slide release spring | |
| 39 Slide release spring pin | |
| 40 Safety lever (left; small) | |
| 41 Safety lever (right; small) | |
| 43 Hammer «SA only» | |
| 44 Hammer pin | |
| 46 Hammer strut | |
| 47 Hammer spring | |
| 48 Pivot | |
| 50 Hammer strut pin | |
| 52 Hammer pin retainer | |
| 57 Trigger «SA only» (straight, long) | |
| 61 Safety lever spring | |
| 62 Safety lever plunger | |

Variant «SA/DA»

- | |
|--------------------------------|
| 27 Trigger «SA/DA» (curved) |
| 43 Hammer «SA/DA» |
| 45 Disconnecter |
| 50 Hammer strut pin (set of 2) |
| 971 Threaded pin M2.5x5 |

Options

- | |
|------------------------------------|
| 140 Safety lever (left; large) |
| 141 Safety lever (right; large) |
| 607 Slide release pin IPSC Redback |

Variant «Carry Optic»

- | |
|---|
| 80 Mounting plate Trijicon SRO |
| 86 Mounting plate Sight-Mark M-Spec |
| 83 Mounting plate Shield RMS |
| 610 Trijicon SRO |
| 612 Sight-Mark SMini Shot M-Spec FMS |
| 613 Shield RMS |
| 910 Countersunk screw Trijicon (set of 2) |
| 912 Countersunk screw Sight-Mark (set of 2) |
| 913 Panhead screw Shield (set of 2) |

SCHEME PHOENIX PREDATOR STANDARD «SA only»

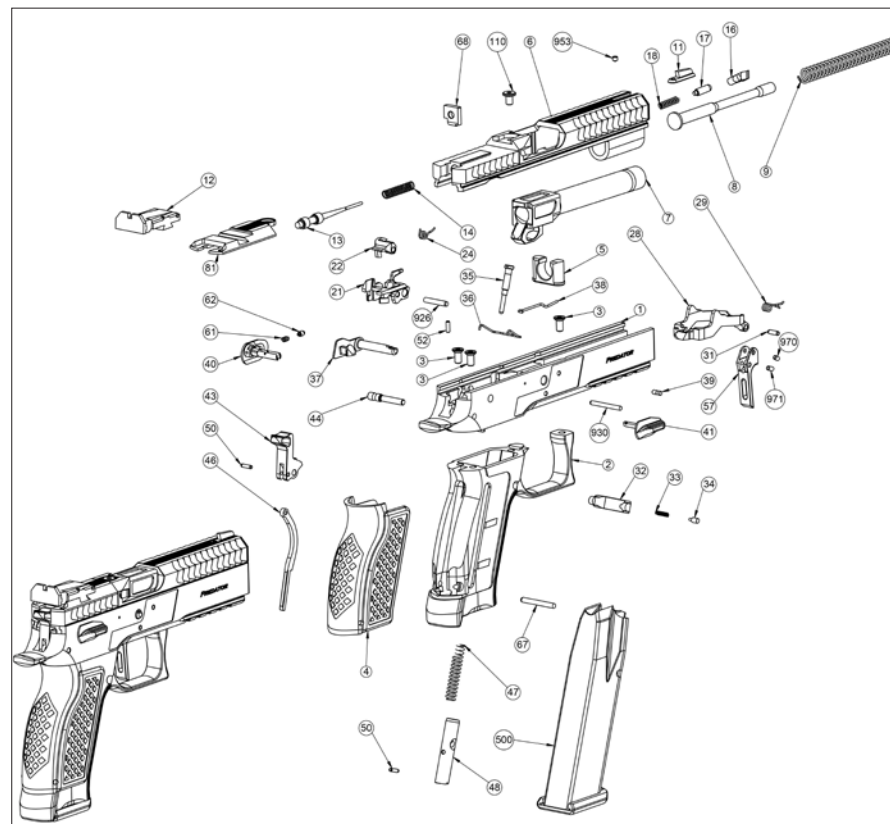

Necessary informations for spare parts orders

- Pistol type (caliber, type designation)
- Pistol number (serial number)
- Spare part number AND designation of the spare part

Order address

PHX Phoenix AG
Switzerland
info@phx.swiss
www.phx.swiss



UNCOMPROMISED QUALITY

PHX PHOENIX AG
Switzerland
info@phx.swiss
www.phx.swiss